

ROHS

技术要求

- 1、插入力: 2.94~29.4N(0.3~3.0kgf)
- 2、拔出力: 2.94~29.4N(0.3~3.0kgf)
- 3、接触电阻:  $\leq 50m\Omega$
- 4、绝缘电阻:  $>100M\Omega$  DC 500V
- 5、耐电压: AC 500V 1min无飞弧及击穿
- 6、寿命: 5000 10~20次/min
- 7、额定负载: DC 12V 1A
- 8、适用温度范围:  $-25\sim 85^{\circ}C$
- 9、推荐使用插头:

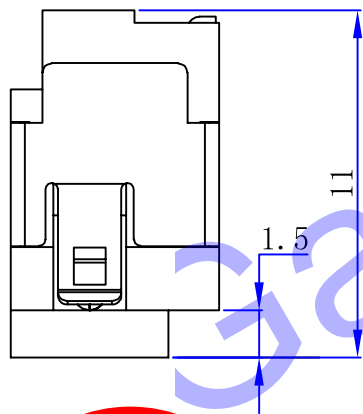
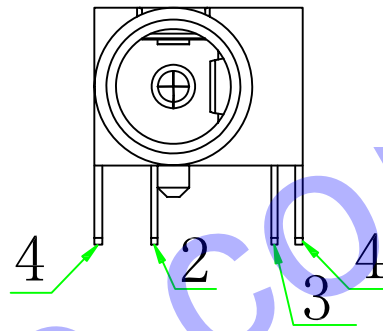
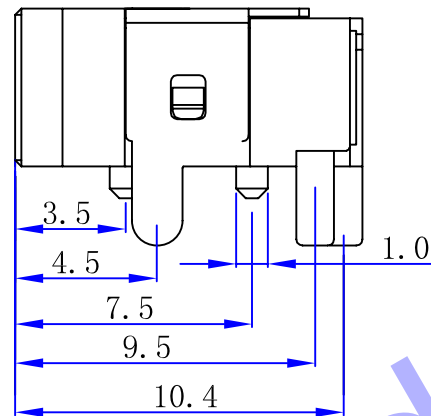
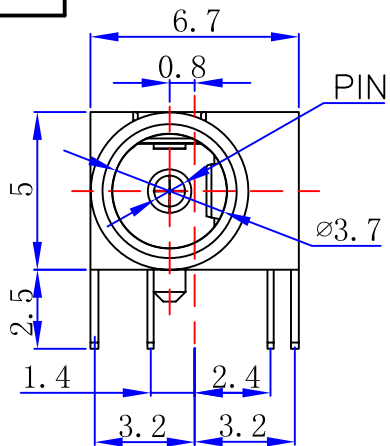

T:1.6 Dimensions of PC board holes  
Tolerance :  $\pm 0.1$ (Printed-sided view)

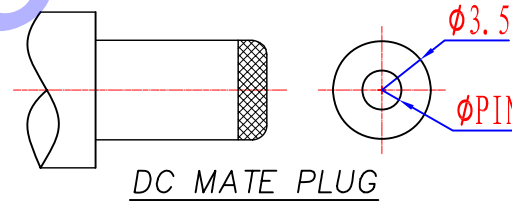
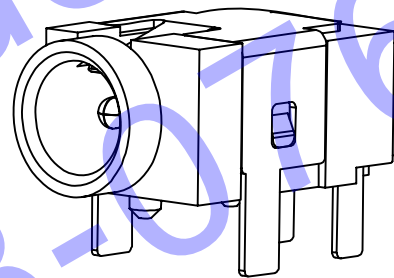
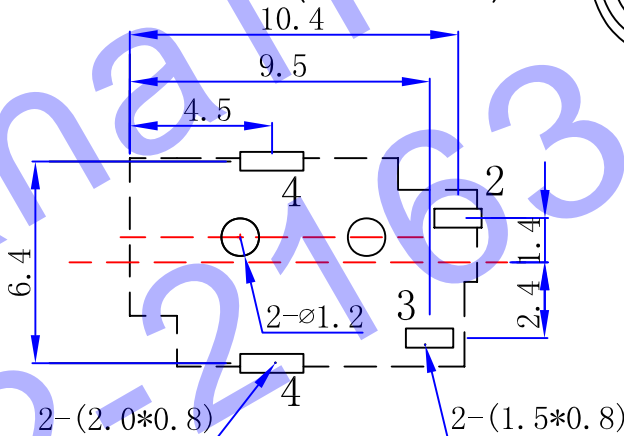

SCHEMATIC

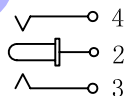

PIN	$\phi 1.0$	$\phi 1.3$
APPD		

6						
5						
4	DC-00310-04	盖子脚	1PCS	C5210黄铜=0.3	镀银	环保
3	DC-00310-03	弹片脚	1PCS	C5191磷铜=0.3	镀银	环保
2	DC-00310-02	PIN	1PCS	H65黄铜=0.25	镀银	环保
1	DC-00310-01	塑料座	1PCS	PPA (BLACK)	黑色	环保
序号	零件图代号	名称	数量	材料	镀层/颜色	备注

1.线性 X ±0.15  
X.X ±0.10  
X.XX ±0.05  
2.角度 XX' ±3°  
X' ±2°  
X.X' ±1°

审核	刘兴	日期	2014.5.20	品名	DC POWER JACK	
批准	陈刚	日期	2014.5.21	型号	<b>DC-00310</b>	
比例		单位	工程部	页码	1F1	A4

变更号 版本 日期