

REV.	QTY	ECN. NO.	REASON/CONTENTS	SIGN	DATE
02			Drawing release	Bull. pa	2011/11/04
A0			Add center pin diameter drawing.	H T Z	2015/9/30
A1			Modification of plating specifications.	H T P	2017/5/16

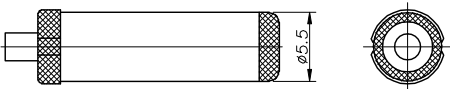

**DC MATE PLUG**

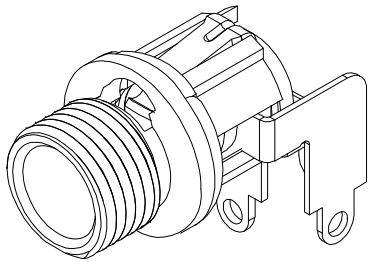
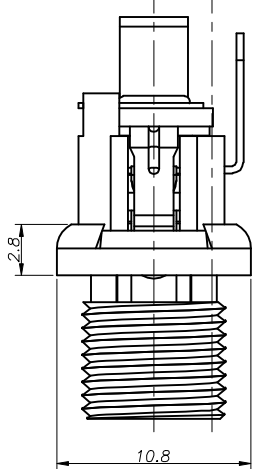
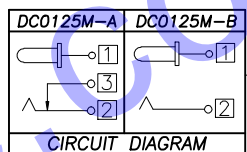

**Ordering information:**  
**DC0125M- □ □ PB OA S 0 4**  
 (1) (2) (3) (4) (5) (6) (7) (8)  
 (1): Series No.  
 (2): Schematic option: A, B  
 (3): Center pin diameter:  
 H=2.0, J=2.5  
 (4): Material of housing:  
 PB=PBT (Standard)  
 (5): Housing color:  
 OA=Black  
 (6): Terminal plating:  
 S=Silver (Ag)  
 (7): Special option:  
 0=No special option  
 (8): Packing mode:  
 4=Bag packing

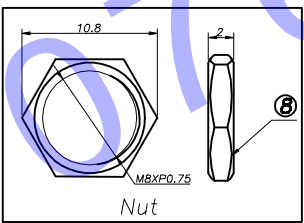
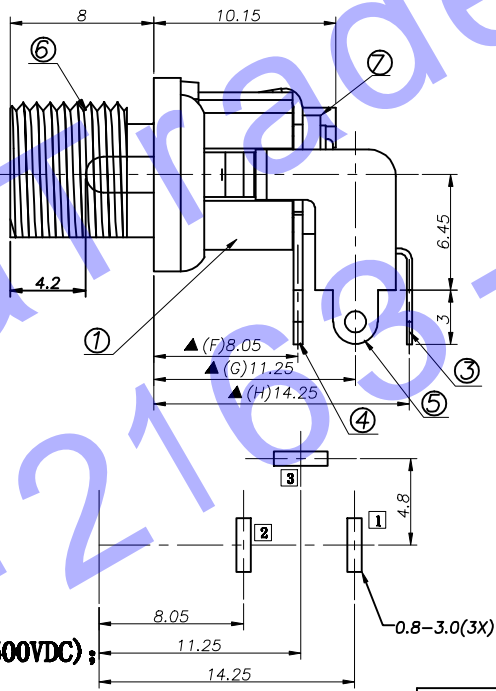
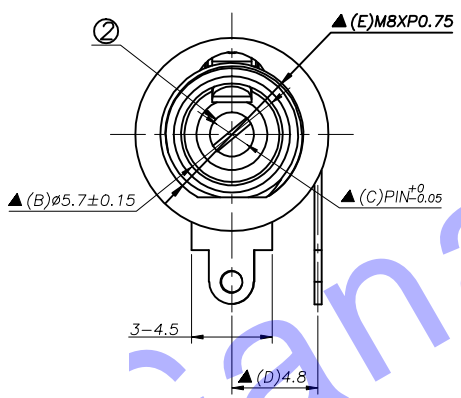

Model No.	DC0125M-__H	DC0125M-__J
Center Pin	2.0	2.5

**Specification:**

- Rating : DC 30V 3.0A;
- Contact resistance:  $\leq 30m\Omega$ ;  
After test:  $\leq 50m\Omega$
- Insulation resistance:  $\geq 100M\Omega$  (500VDC);  
After test:  $\geq 50M\Omega$
- Withstanding voltage: 500VAC ;
- Insertion and extraction force: 3N~30N;
- life test: 5000cycles min;
- Operation temperature range: -20℃~70℃
- Preservative temperature range: -40℃~85℃
- Sign "▲" is importance dimension.

**RECOMMENDED P.C.B. LAYOUT**  
**UNSPECIFIED TOLERANCE: ±0.05**  
**(COPPER-SIDED VIEW)**

THIS DOCUMENT IS THE SOLE PROPERTY OF HONG HONG ELECTRONICS CO., LTD. AND SHOULD NOT BE USED IN WHOLE OR IN PART WITHOUT PRIOR WRITTEN PERMISSION.

NO.	DESCRIPTION	QTY	MATERIAL	PLATING
8	Nut	1	Brass	Nickel plating
7	Washer	2	Bakelite(PF)	
6	Bushing	1	Brass	CuSn plating
5	Shunt Terminal	1	Phosphor bronze	Silver plating
4	Tip Spring	1	Phosphor bronze	Silver plating
3	Center pin terminal	1	Brass (C2680-H)	Silver plating
2	Center pin	1	Brass (H65)	CuSn plating
1	Housing	1	PBT,UL 94V-0	Black

UNIT:MM	TOLERANCE	TYPE:	MODEL NO:	DRAWING TYPE:				
THIRD ANGLE	DIMENSIONS	X ±5°	DC0125M-__PBOAS04	CUSTOMER DRAWING				
	.X ±0.30				DRAWING NO:	SCALE	VER.	PAGE
	.XX ±0.30							
.XXX ±0.15	.XX ±2°							

DESIGNER BY:  
 CHECK BY:  
 APPROVED BY:

H D C 有限公司