

RECEPTACLES SYSTEM

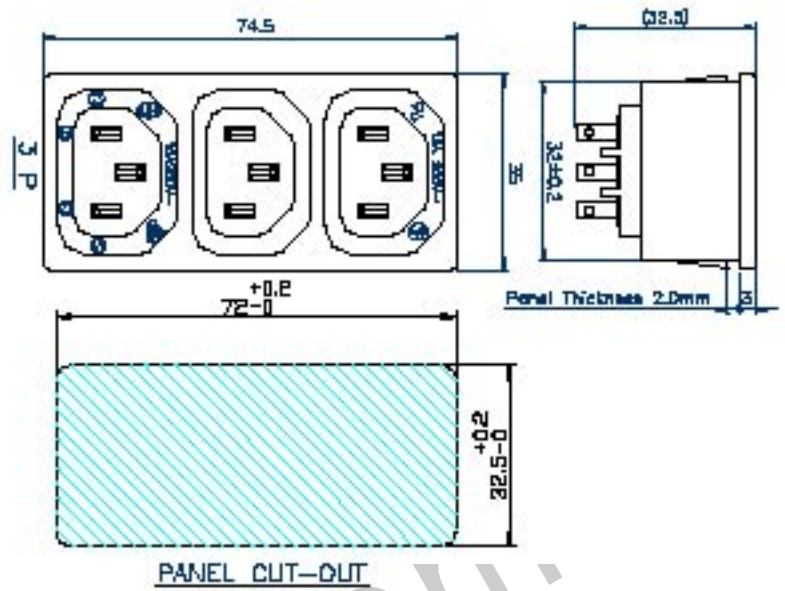

742W-3P

STANDARD : IEC 60320-2-2 sheet F(C1)
 RATING : 15A250V AC
 RATING : UL/CSA
 RATING : 10A250V
 APPROVALS : VDE/CCC

742W-3P 成品編碼規則

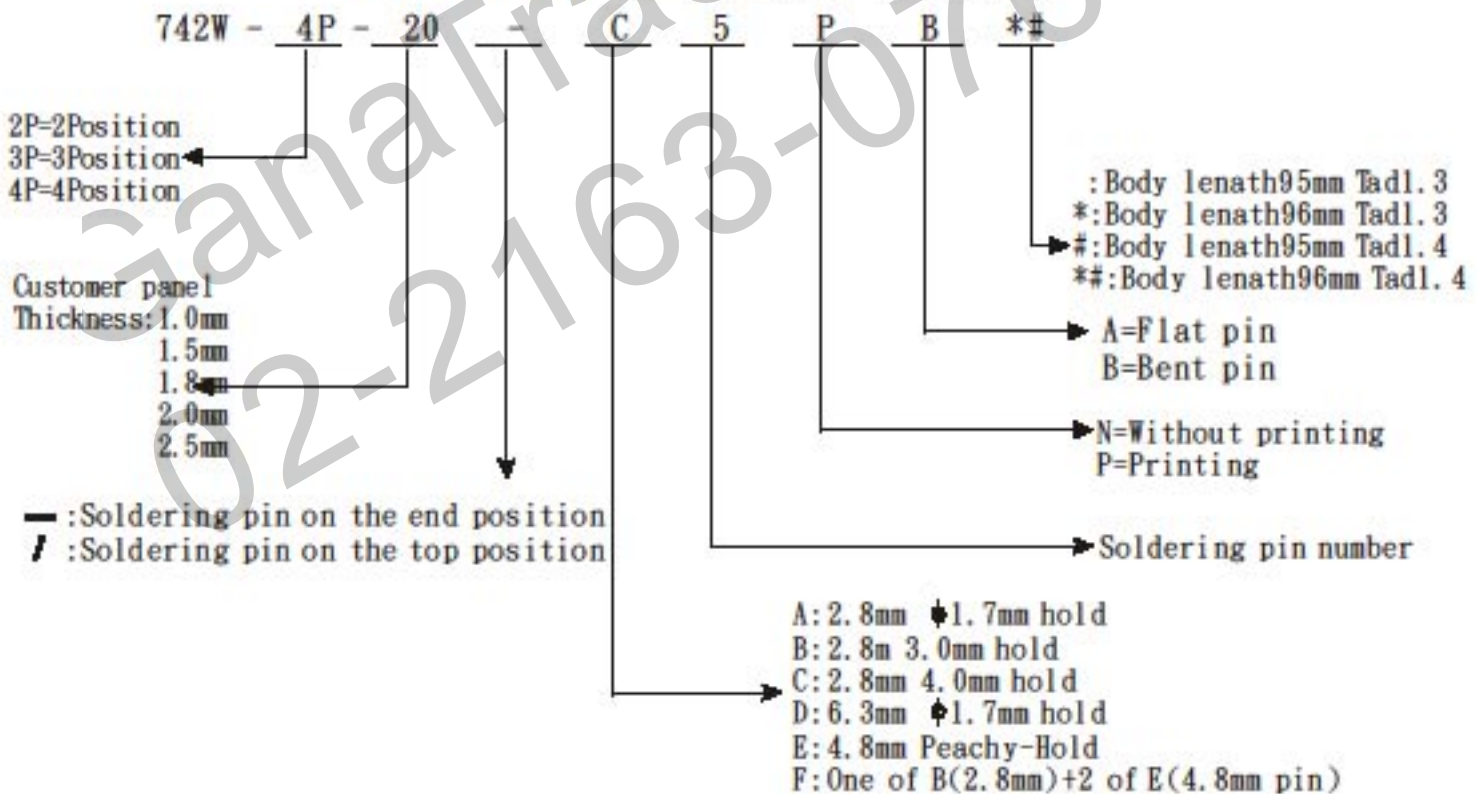

Byword: 742W-4P-20_C_5_P_B_*

4 Position 2.0mm panel thickness 4.0mm soldering pin
 5 bent pins with printing hole 96mm length