

0.5A-卧贴上接承认图面

REV.	DESCRIPTION	DATE
A/0	原始版本	07.06.10
A/1	修订版本	08.09.20

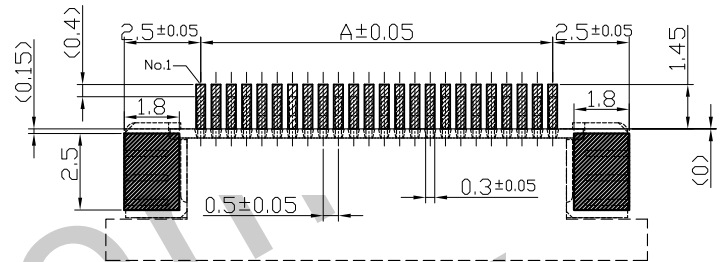
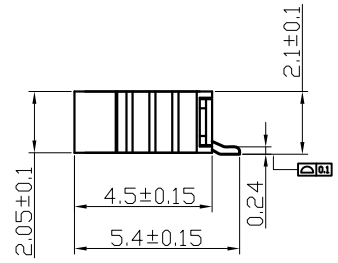
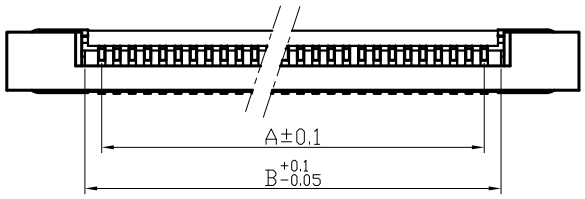

适用线路板
RECOMMENDED PCB LAYOUT

Pin位	Type	A	B	C	Pin位	Type	A	B	C
4	0.5A-4PBS	1.5	2.6	7.7	33	0.5A-33PBS	16	17.1	22.2
5	0.5A-5PBS	2	3.1	8.2	34	0.5A-34PBS	16.5	17.6	22.7
6	0.5A-6PBS	2.5	3.6	8.7	35	0.5A-35PBS	17	18.1	23.2
7	0.5A-7PBS	3	4.1	9.2	36	0.5A-36PBS	17.5	18.6	23.7
8	0.5A-8PBS	3.5	4.6	9.7	37	0.5A-37PBS	18	19.1	24.2
9	0.5A-9PBS	4	5.1	10.2	38	0.5A-38PBS	18.5	19.6	24.7
10	0.5A-10PBS	4.5	5.6	10.7	39	0.5A-39PBS	19	20.1	25.2
11	0.5A-11PBS	5	6.1	11.2	40	0.5A-40PBS	19.5	20.6	25.7
12	0.5A-12PBS	5.5	6.6	11.7					
13	0.5A-13PBS	6	7.1	12.2					
14	0.5A-14PBS	6.5	7.6	12.7					
15	0.5A-15PBS	7	8.1	13.2					
16	0.5A-16PBS	7.5	8.6	13.7					
17	0.5A-17PBS	8	9.1	14.2					
18	0.5A-18PBS	8.5	9.6	14.7					
19	0.5A-19PBS	9	10.1	15.2					
20	0.5A-20PBS	9.5	10.6	15.7					
21	0.5A-21PBS	10	11.1	16.2					
22	0.5A-22PBS	10.5	11.6	16.7					
23	0.5A-23PBS	11	12.1	17.2					
24	0.5A-24PBS	11.5	12.6	17.7					
25	0.5A-25PBS	12	13.1	18.2					
26	0.5A-26PBS	12.5	13.6	18.7					
27	0.5A-27PBS	13	14.1	19.2					
28	0.5A-28PBS	13.5	14.6	19.7					
29	0.5A-29PBS	14	15.1	20.2					
30	0.5A-30PBS	14.5	15.6	20.7					
31	0.5A-31PBS	15	16.1	21.2					
32	0.5A-32PBS	15.5	16.6	21.7					

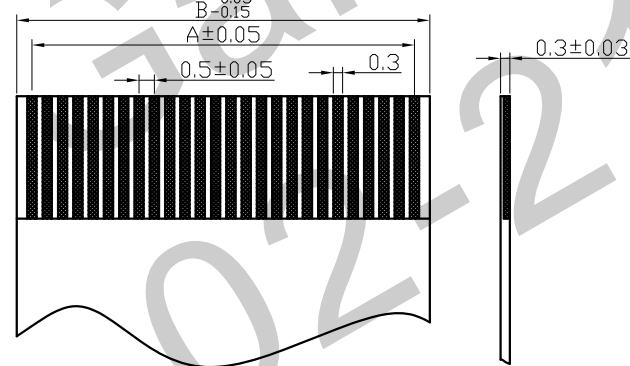
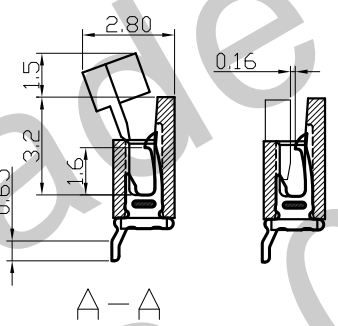
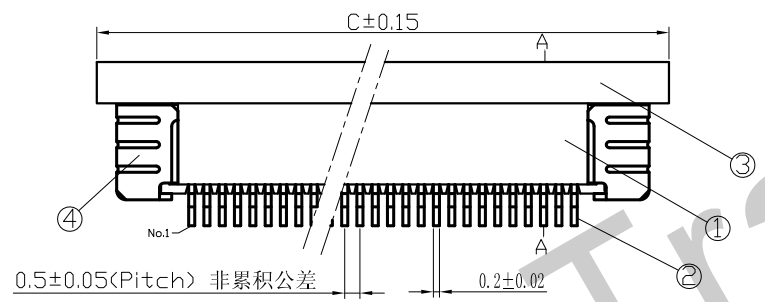

技术指标:

- 1、塑件表面应光洁、无毛刺、明显收缩、缺陷、裂纹等现象;
- 2、温度范围: -25° C~85° C;
- 3、额定电压: 50V, AC, DC(等效);
- 4、接触电阻: ≤0.03 Ω;
- 5、绝缘电阻: ≥500M Ω;
- 6、耐压: 500V, AC/minute.

ROHS管理规定:

- 1、禁止使用含有ROHS指令所限制的物质。
- 2、对应的SGS或ITS出具的ICP-AES数据、不可测定物质的成分表, 有效期一年。

适用FPC寸法
APPLICABLE FPC

4	100-0200-004	弹片 Fitting Nail	磷青铜 Phosphor Bronze	2	电镀(铜): 整个表面镀层50u"MIN,再镀锡 120u"MIN..
3	100-0400-003	铆 Actuator	PPS(UL94V-0)	1	黑色/紫色
2	100-0100-002	端子 Contact	磷青铜 Phosphor Bronze	n×1	电镀(铜): 整个表面镀层50u"MIN,再镀锡 120u"MIN..
1	100-0300-001	基 Housing	PA46/LCP(UL94V-0)	1	枪

序号	图号	名称	材料	数量	附注
未注公差					
X.° ±3° X.X° ±0.5°					
<10	10-30	>30	单位	比例	Design Units
±0.2	±0.25	±0.3	MM Only	—	METRIC
制作	审核	批准	材料	图号	100-1000-020
胡海针	洪新江	H.D.R	见图解	品名	Part No F050010-**-0**
					0.5A-nPBS

HDC 有限公司

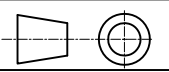

旧底图总号
底图总号
签字
日期