

1.0E-弯插上接错脚承认图面

REV.	DESCRIPTION	DATE
A/0	原始版本	07.06.10
A/1	修订版本	08.09.20

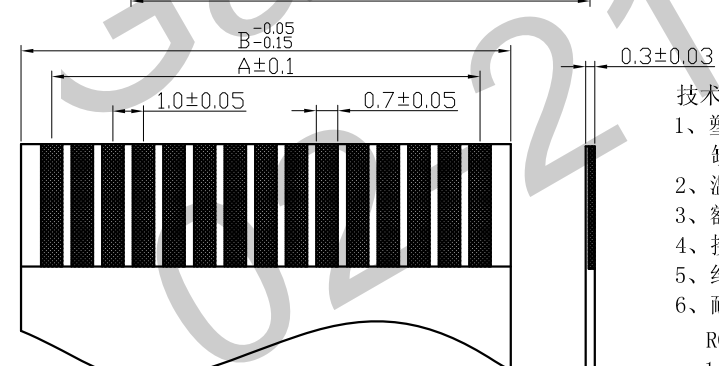
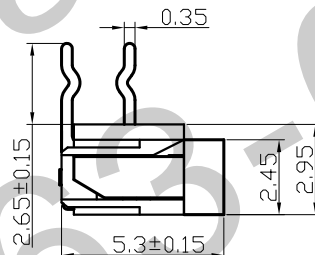
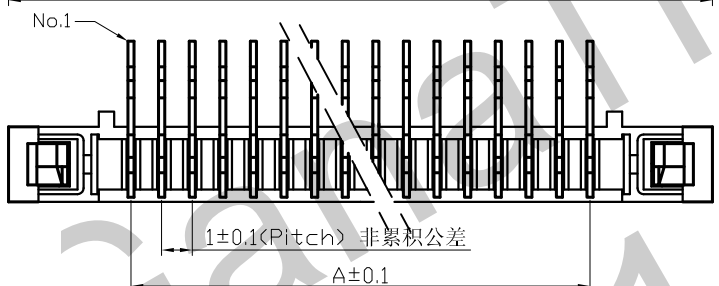
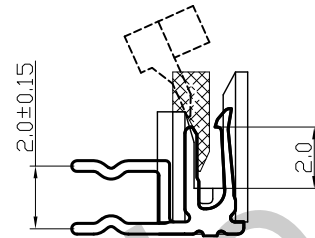
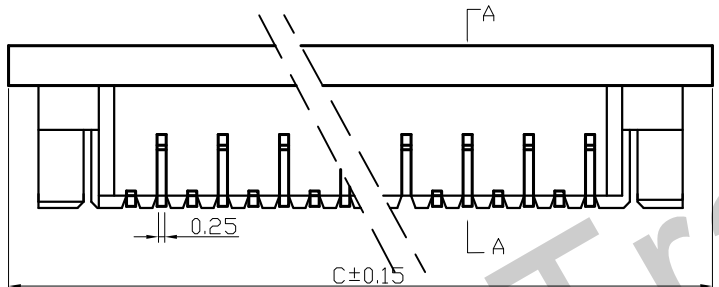
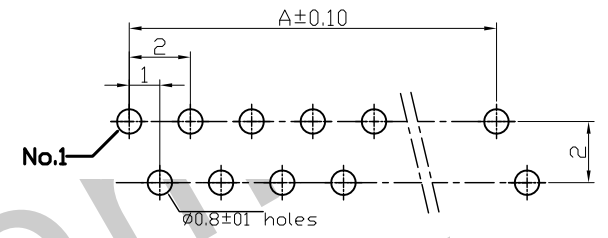
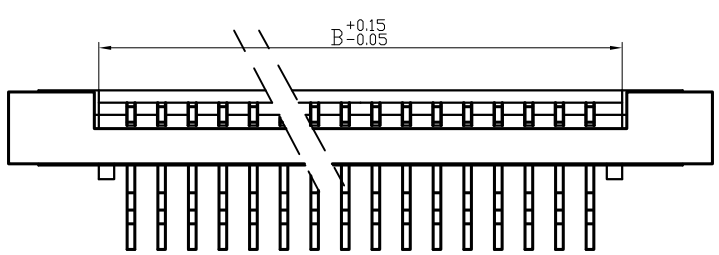

适用线路板
RECOMMENDED PCB LAYOUT

Pin 位	Type	A	B	C	Pin 位	Type	A	B	C
4	1.0E-4PWSF	3	5.1	11	23	1.0E-23PWSF	22	24.1	30
5	1.0E-5PWSF	4	6.1	12	24	1.0E-24PWSF	23	25.1	31
6	1.0E-6PWSF	5	7.1	13	25	1.0E-25PWSF	24	26.1	32
7	1.0E-7PWSF	6	8.1	14	26	1.0E-26PWSF	25	27.1	33
8	1.0E-8PWSF	7	9.1	15	27	1.0E-27PWSF	26	28.1	34
9	1.0E-9PWSF	8	10.1	16	28	1.0E-28PWSF	27	29.1	35
10	1.0E-10PWSF	9	11.1	17	29	1.0E-29PWSF	28	30.1	36
11	1.0E-11PWSF	10	12.1	18	30	1.0E-30PWSF	29	31.1	37
12	1.0E-12PWSF	11	13.1	19	31	1.0E-31PWSF	30	32.1	38
13	1.0E-13PWSF	12	14.1	20	32	1.0E-32PWSF	31	33.1	39
14	1.0E-14PWSF	13	15.1	21	33	1.0E-33PWSF	32	34.1	40
15	1.0E-15PWSF	14	16.1	22	34	1.0E-34PWSF	33	35.1	41
16	1.0E-16PWSF	15	17.1	23	35	1.0E-35PWSF	34	36.1	42
17	1.0E-17PWSF	16	18.1	24	36	1.0E-36PWSF	35	37.1	43
18	1.0E-18PWSF	17	19.1	25	37	1.0E-37PWSF	36	38.1	44
19	1.0E-19PWSF	18	20.1	26	38	1.0E-38PWSF	37	39.1	45
20	1.0E-20PWSF	19	21.1	27	39	1.0E-39PWSF	38	40.1	46
21	1.0E-21PWSF	20	22.1	28	40	1.0E-40PWSF	39	41.1	47
22	1.0E-22PWSF	21	23.1	29					

- 技术指标:
- 1、塑件表面应光洁、无毛刺、明显收缩、缺陷、裂纹等现象;
 - 2、温度范围: -25°C~85°C;
 - 3、额定电压: 50V, AC, DC(等效);
 - 4、接触电阻: ≤0.03Ω;
 - 5、绝缘电阻: ≥500MΩ;
 - 6、耐压: 500V, AC/minute.

- ROHS管理规定:
- 1、禁止使用含有ROHS指令所限制的物质。
 - 2、对应的SGS或ITS出具的ICP-AES数据、不可测定物质的成分表, 有效期一年。

适用FPC寸法
APPLICABLE FPC

3	124-0400-003	触 Actuator	PPS(UL94V-0)	1	黑色/紫色
2	124-0100-004	端子 Contact	磷青铜 Phosphor Bronze	n×1	电镀(铜): 整个表面镀层30u"MIN, 再镀铜80u" MIN.
1	124-0300-001	基座 Housing	PA46(UL94V-0)	1	棕色
序号	图号	名称	材料	数量	附注
未注公差			HDC 有限公司		
X.° ±3° X.X° ±0.5°					
<10	10-30	>30	单位	比例	Design Units
±0.2	±0.25	±0.3	MM Only	—	METRIC
制作	审核	批准	材料	图号	124-1000-023
胡海针	洪新江	H.DR	见图解	品名	1.0E-nPWSF

旧底图总号
底图总号
签字
日期