

NO	MODEL	L(mm)
1		
2		

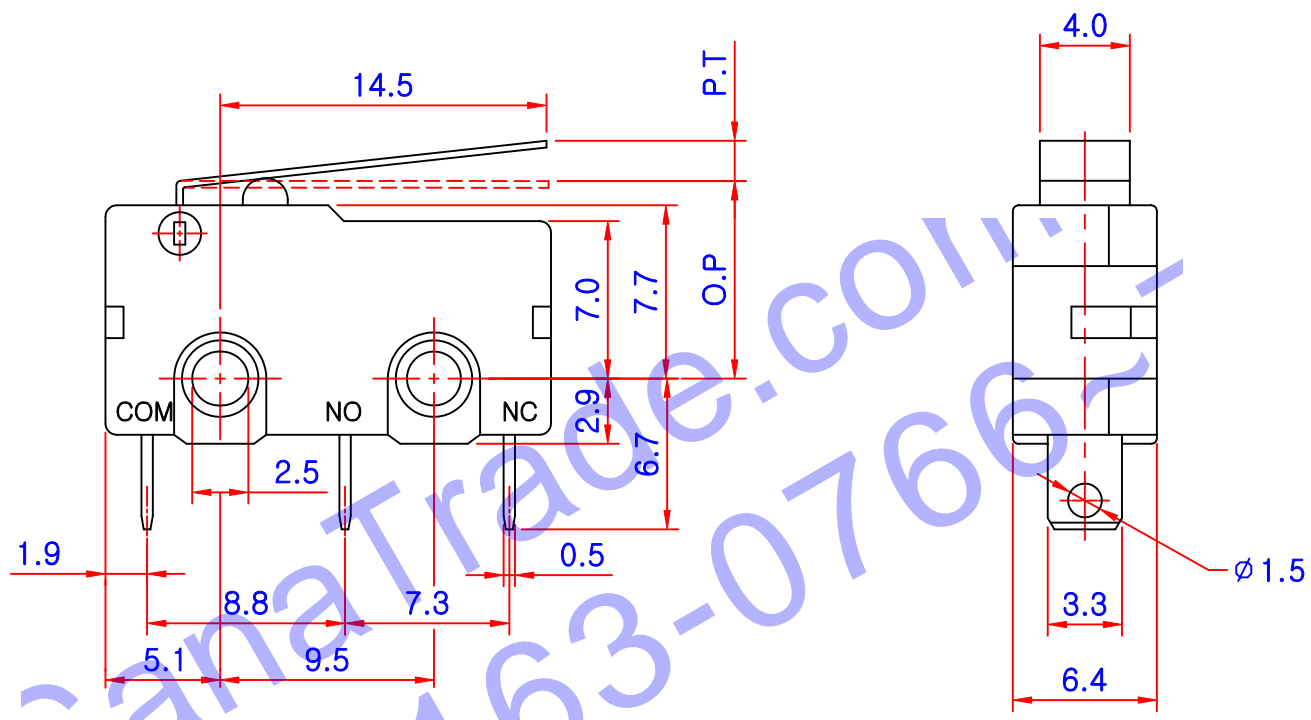

CIRCUIT DIAGRAM

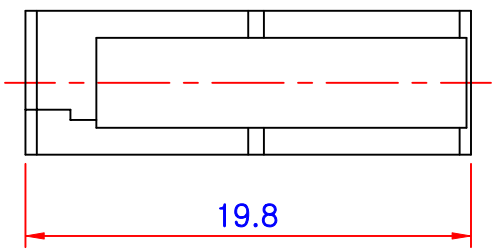
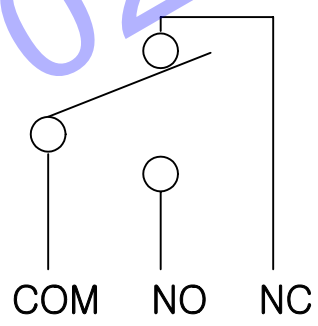

OPERATION CHARACTERISTICS		
OPERATING FORCE	(O.F)	MAX. 50gf
RELEASE FORCE	(R.F)	MIN. 6gf
PRE TRAVEL	(P.T)	MAX. 2.5
OVER TRAVEL	(O.T)	MIN. 1.2
MOVEMENT DIFFERENTIAL	(M.D)	MAX. 0.8
OPERATING POSITION	(O.P)	8.8±0.8

DRAWN	DESIGNED	CHECKED	APPROVED
Kim jong pil			

MODEL NO :
TITLE : MICRO S/W ASS"Y

SCALE : 5 : 1
 FILE NO :
 DATE : 2003

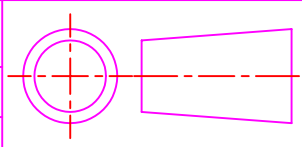

DWG NO ;