

REV. LTR.	DESCRIPTION	SIGN	DATE

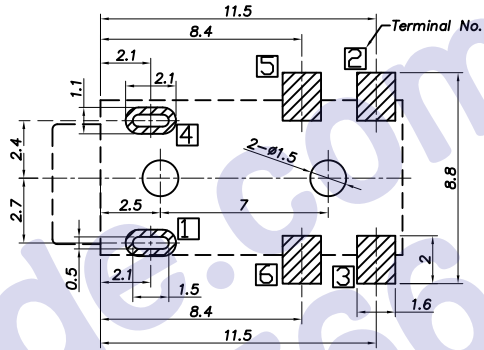
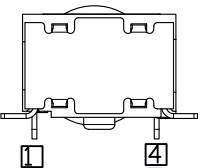
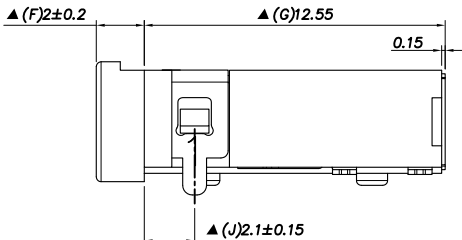
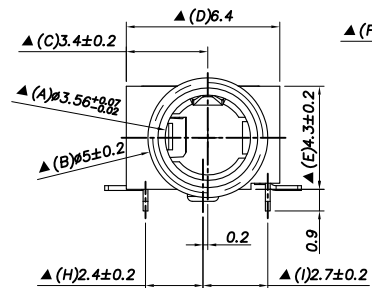
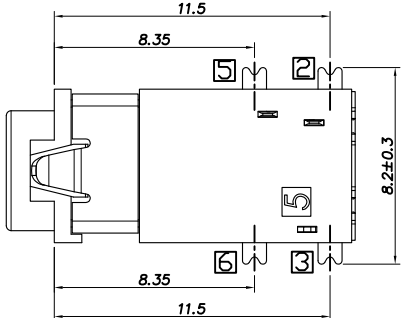
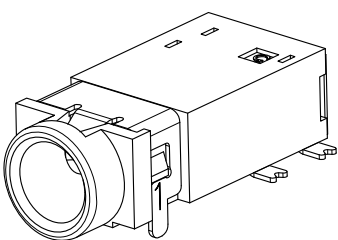

P.C.B Layout
(Copper-sided view)

Ordering information:
P.J31360 - □ □ □ A G □ 0

① ② ③ ④ ⑤ ⑥ ⑦

- ①: Series No.
- ②: Schematic option:
I, J, M, A, B, D
- ③: Material of housing:
9T=PA9T, 10=PA10T
- ④: Bushing or Housing color:
0A=Black(Standard)
- ⑤: Terminal plating
G=Gold(Au)
- ⑥: Special option:
00=No special option
H0=All plastic is Halogen Free
- ⑦: Packing mode:
1=Reel packing

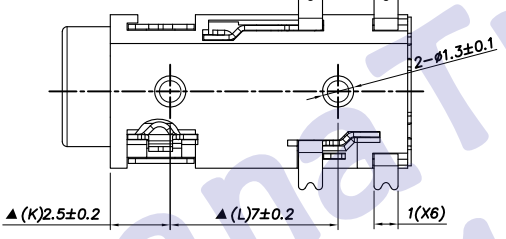
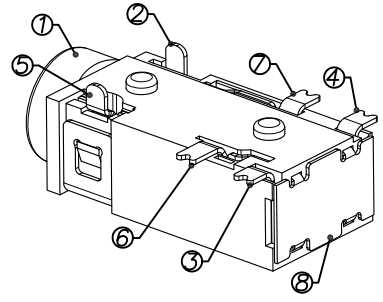

Model No.	P.J31360	P.J31360	P.J31360	P.J31360	P.J31360	P.J31360
Schematic code						

□ Terminal No.

Specification:
 1. Rating :DC 30V 0.5A;
 2. Contact resistance: ≤30mΩ;
 After test: ≤50mΩ
 3. Insulation resistance: ≥100MΩ (500VDC);
 After test: ≥50MΩ
 4. Withstand voltage: 500VAC ;
 5. Insertion and extraction force: 3N
 6. life test: 5000cycles min;
 7. Operation temperature range: -20
 8. Preservative temperature range: -40
 9. Sign "▲" is importance dimension

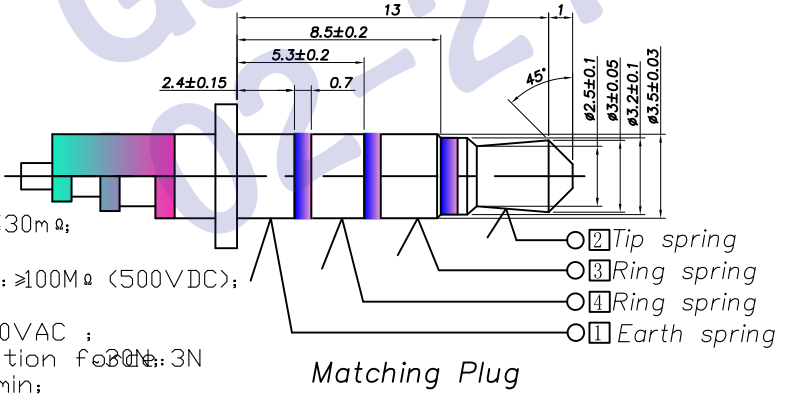

Matching Plug

⑧ Shield	1	Stainless steel 0.15t	PJ31360-W1	
⑦ Shunt terminal ⑥	1	Phosphor bronze 0.2t	PJ31360-06	Gold plating
⑥ Shunt terminal ⑤	1	Phosphor bronze 0.2t	PJ31360-05	Gold plating
⑤ Ring spring ④	1	Phosphor bronze 0.2t	PJ31360-04	Gold plating
④ Ring spring ③	1	Beryllium bronze 0.2t	PJ31360-03	Gold plating
③ Tip spring ②	1	Beryllium bronze 0.2t	PJ31360-02	Gold plating
② Earth spring ①	1	Phosphor bronze 0.2t	PJ31360-01	Gold plating
① Housing	1	PA9T/PA10T, UL94 V-0	PJ31360-S1	Black

ITEM No.	DESCRIPTION	QTY	MATERIAL	PART NO.	REMARK
----------	-------------	-----	----------	----------	--------

UNIT:MM	TYPE:	MODEL NO.:	PAPER NO: A4	PAGE 1 OF 1
	3.5 PHONE JACK	PJ31360-_- _0AG001	TOLERANCE ±0.25	ANGLES ±2°
DESIGNER BY:	Wangyan		SCALE FULL	VER 0
CHECK BY:	2010.05.28			
APPROVED BY:				

HDC有限公司