

SUGGESTED PCB LAYOUT  
(TOP VIEW)

**ELECTRICAL SPECIFICATIONS @ 25°C +/- 5°C unless otherwise noted:**

**Insertion Loss: 1-100MHZ -1.0dB MAX**

**Return Loss: 1-30MHZ -16.0dB MIN**  
**30-60MHZ -14.0dB MIN**  
**60-80MHZ -10.0dB MIN**

**Cross Talk: 1-30MHZ -40.0dB MIN**  
**30-60MHZ -35.0dB MIN**  
**60-80MHZ -30.0dB MIN**

**CMR: 1-100MHZ -35.0dB MIN**

**Hi-Pot: 1500v AC 6S 1mA**

**OCL:350uH MIN @ 100KHZ 100mV 8mA DC**

**Contacts: 0.35mm thick phos bronze plated with 6u' gold in contact area**

**Operating temperature range:0°C to +70°C**

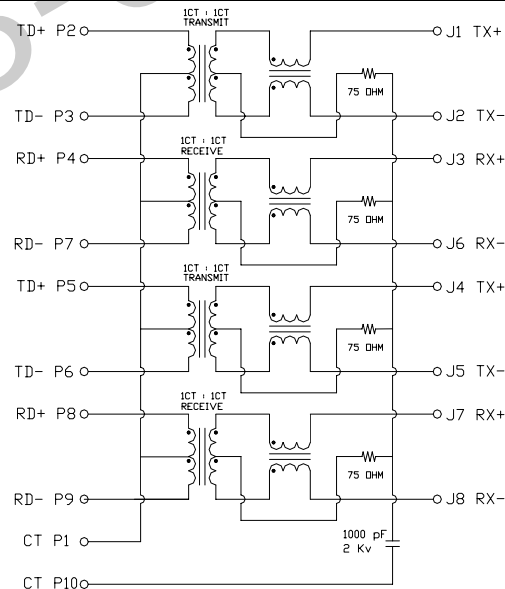

**Turn Ratio: 1CT:1CT+/-3%**

**Housing Material: PBT Black**

HDC 有限公司

Drafted by CZ Lin

UNIT: mm

.xx +/-0.25 .xxx +/-0.13

1000BASE  
1X1Tab-Down RJ45

Approved By : Herman Au

P/N: GRJJ-H7172

Sheet 1 of 1

REV.  
A