

REV	MODIFICATION	DATE	DRAW	APPROVE
A	圖面發行	2012/10/29	JDL	Oscar

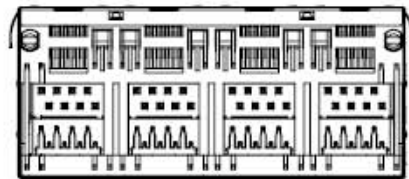

NOTES:

- MATERIAL:**
- HOUSING MATERIAL :GLASS FILLED POLYESTER(UL94V-0).
 - CONTACT MATERIAL :PHOSPHOR BRONZE Ø0.46mm (C5100).
 - PLATING :GOLD PLATING OVER NICKEL.
 - SHIELD COPPER ALLOY(OR STEEL ALLOY) 0.20mm THICKNESS PLATING NI.
 - LED OPTION.
- ELECTRICAL:**
- VOLTAGE RATING :125 VAC RMS.
 - CURRENT RATING :1.5 AMP.
 - CONTACT RESISTANCE :50 MILLIOHMS MAX.
 - INSULATION RESISTANCE :500 MEGOHMS MIN @ 500V DC.
 - DIELECTRIC WITHSTANDING RESISTANCE :1000V AC RMS 50Hz, 1MIN.
 - LED RATINGS:FORWARD VOLTAGE:2.2 VOLTS TYPICAL.
REVERSE VOLTAGE:5 VOLTS MAXIMUM.
- MECHANICAL:**
- DURRABILITY:750 CYCLES MIN.
 - PCB RETENTION PRE-SOLDER
- ENVIRONMENTAL:**
- STORAGE : -40°C TO +85°C.
 - OPERATION: -20°C TO 70°C.
- MATES WITH MODULAR PLUG CONFORMING TO FCC PART 68,SUBPART F.

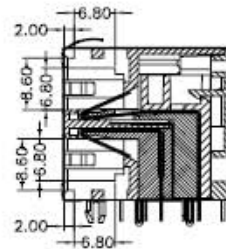
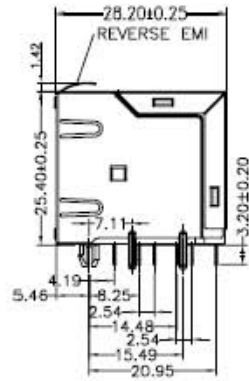
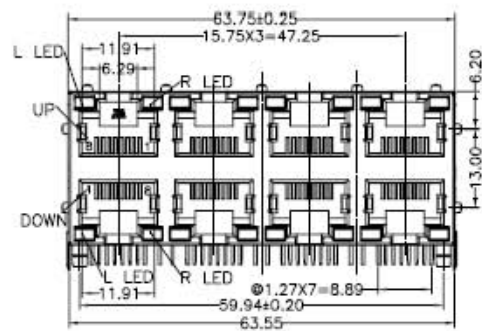
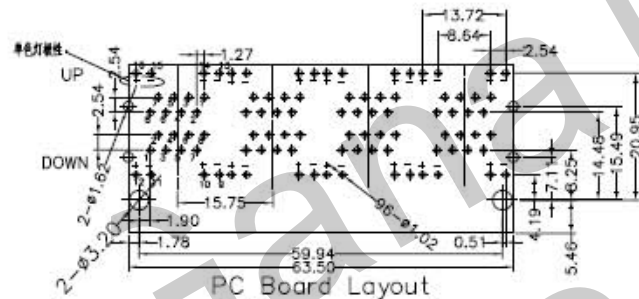
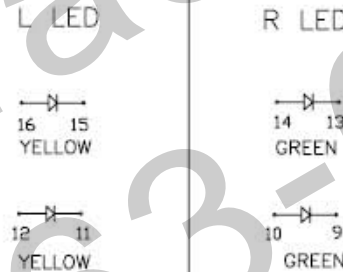

PC Board Layout

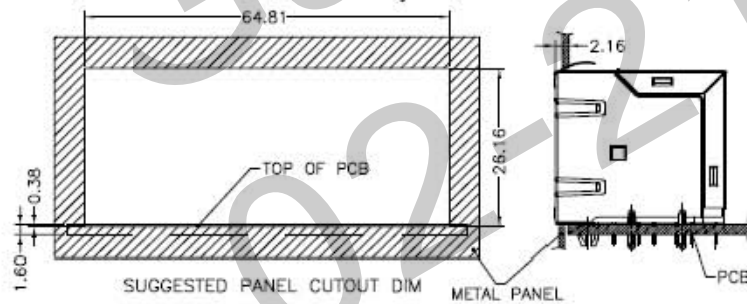

QC : Inspection Item	Cp/Cpk and SPC Control Item	DIMENSION IN mm [Inch]		HDC 有限公司						
		TOLERANCE UNLESS OTHERWISE SPECIFIED				檔案號 FILE NO.	圖號 DWG NO.			
		.X±0.20	X.*±1*	名稱 TITLE	59D 2X4 8PBC PCB JACK&SHIELDED WITH EMI FINGER SIDE ENTRY,FLAT PIN					
		.XX±0.15	.X*±0.5*		圖法 DRAW	電法 PROJ.	圖紙 SCALE	圖號 SIZE	頁數 SHEET	1 / 1
.XXX±0.075		核准 APPROVE	審核 CHECK	Oscar	比例 SCALE	1:1	圖紙 SIZE	A3	頁數 REV	1 / 1