

TIME LAG DIAGRAM

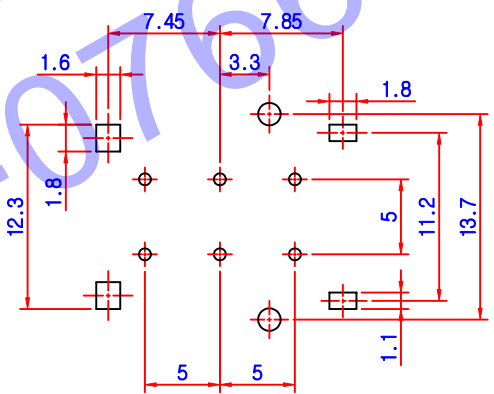

CIRCUIT DIAGRAM (VIEW "A")

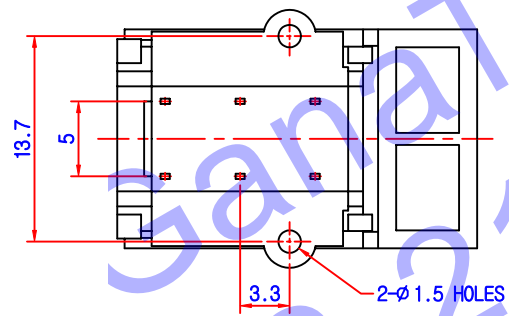
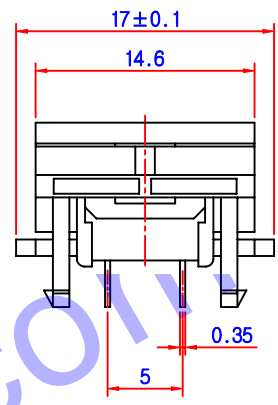
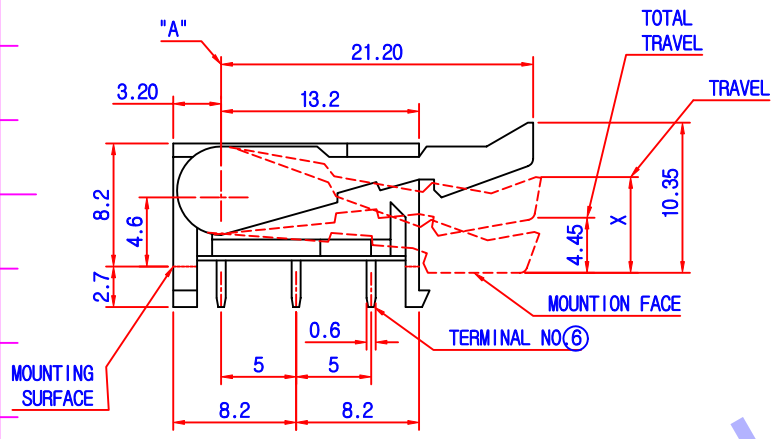
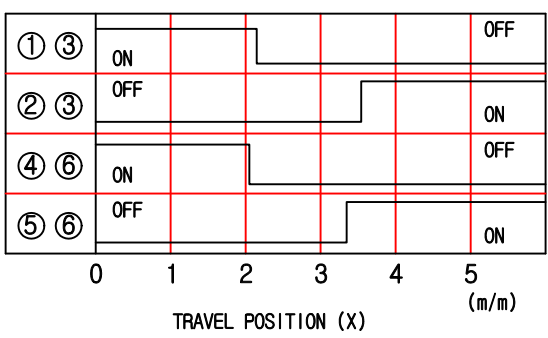
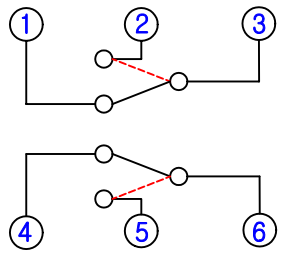

* NOTES

1. RATING : 48V DC. 200mA
2. CIRCUIT : 2C - 2P
3. CONTACT RESISTANCE : 50mΩ MAX.
4. OPERATING FORCE : MAX 70gf

DWG . BY	DES ' N BY	CH ' D BY	APP ' O BY
Kim jong pil			

MODEL NO :
TITLE : HOOK S/W ASS"Y

SCALE :
 FILE NO : 2 : 1
 DATE : 2003 ,

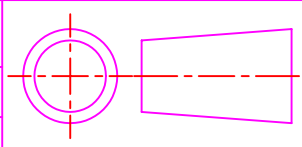

DWG NO ;