

NO	M O D E L	L(mm)
1	SS-2205	2
2	SS-2205 A	4
3	SS-2205 B	6

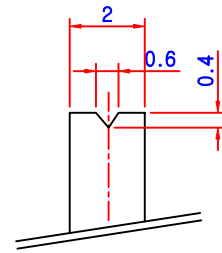

DETAIL KNOB (5:1)

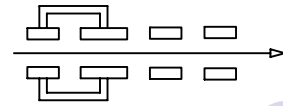
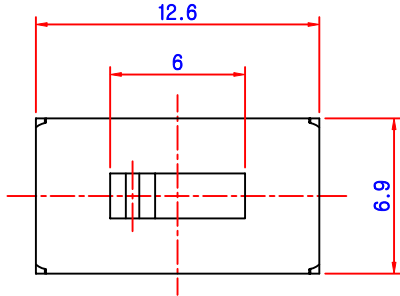

CIRCUIT DIAGRAM

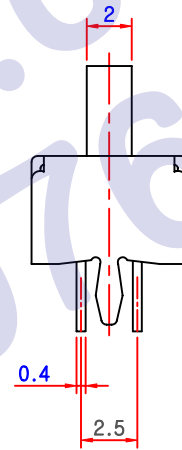
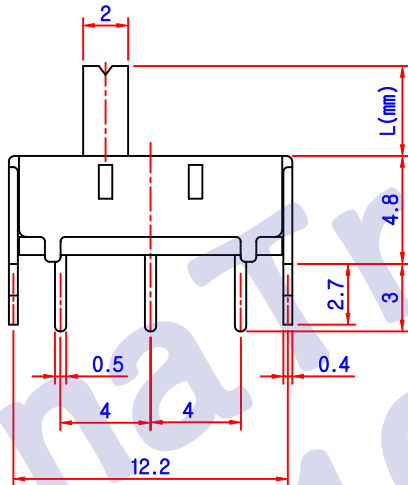

P.C.B DIAGRAM

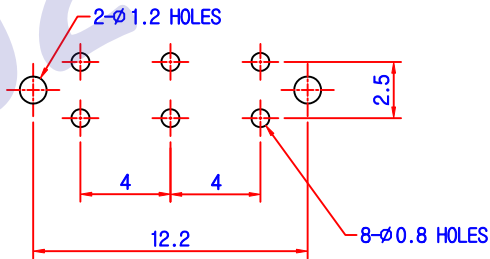

* NOTES

1. RATING : 30V DC, 0.2A
2. CIRCUIT : 2C - 2P
3. TIMING : NON SHORTING
4. TRAVEL : 4.0 mm
5. OPERATING FORCE : 250 ± 100 gf

DWG . BY DES ' N BY CH ' D BY APP ' O BY

MODEL NO :

Kim jong pil

TITLE : SLIDE S/W ASS'Y

SCALE : 3 : 1

FILE NO :

DATE : 2003 , 7 , 26

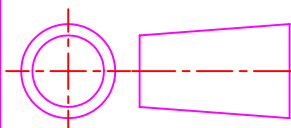

DWG NO ;