

F

E

D

C

B

A

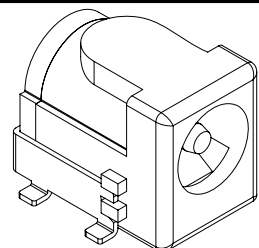

RoHS
Compliant

ZONE	SYMBOL	REVISION	APPROVAL	DATE
		UPDATE THE DWG.	J.X.KUANG	30-4-2012

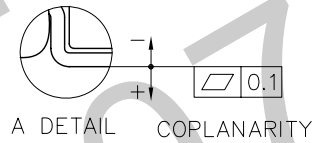
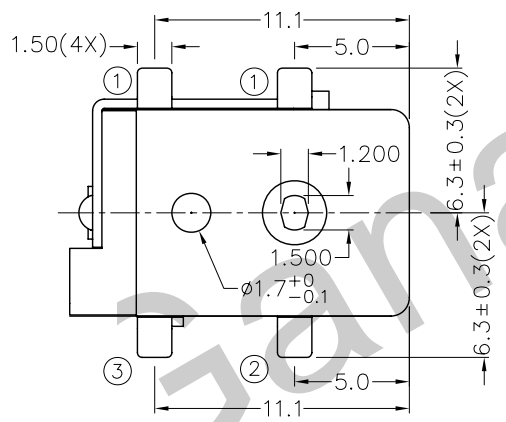
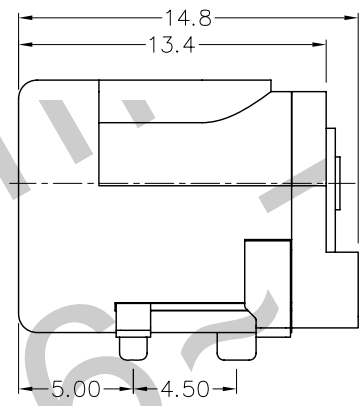
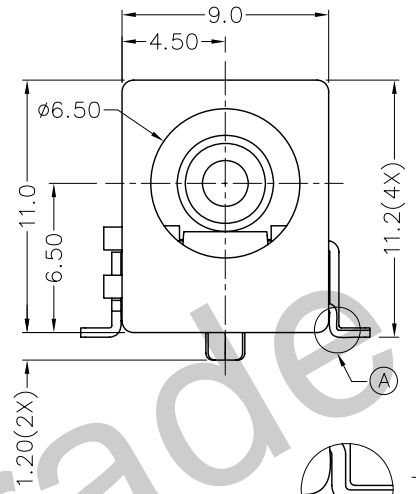
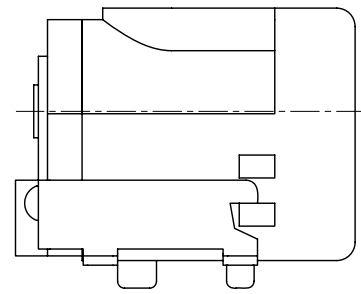

* MATERIAL
 CENTRE PIN : COPPER
 TERMINAL 1 : BRASS
 TERMINAL 2 : COPPER ALLOY
 TERMINAL 3 : BRASS
 HOUSING : PA6T
 COVER : PA6T

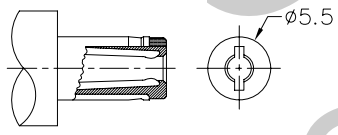
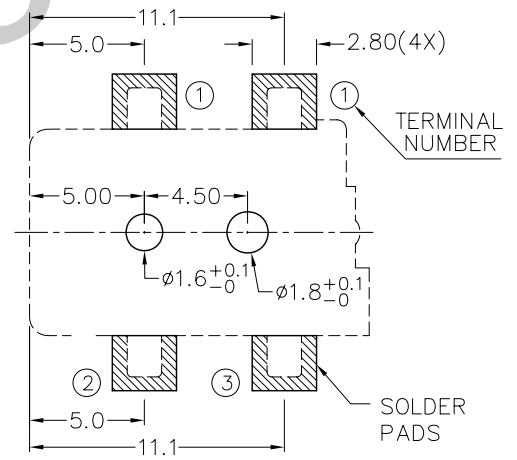

DC MATE PLUG

MODEL NO.	TDC-016H
SCHEMATIC	
CENTER PIN	φ2mm
	φ2.5mm



TECHNIK INDUSTRIAL CO. LTD.

DESIGN	K.Y.AU-YEUNG	DATE	9-10-2003	SCALE	3:1
DRAWING	T.Y.LI	DATE	30-4-2012	MATERIAL	*
CHECK		DATE		DWG. NO.	TZ\DC016H-PA6T/E
APPROVAL		DATE		SHEET	

PART NAME	HIGH CURRENT SMD DC POWER SOCKET	TOLERANCE UNLESS	0.0±0.2	UNIT:	
PART NO.	TDC-016H	OTHERWISE SPECIFIED:	0.00±0.1 0.000±0.05	mm	

F

E

D

C

B

A