

F

E

D

C

B

A

ZONE	SYMBOL	REVISION	APPROVAL	DATE
		ADDED INDICATION OF COPLANARITY	J.X.KUANG	27-4-2010

RoHS  
Compliant

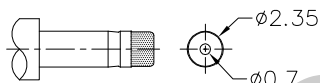
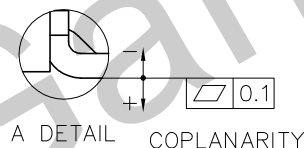
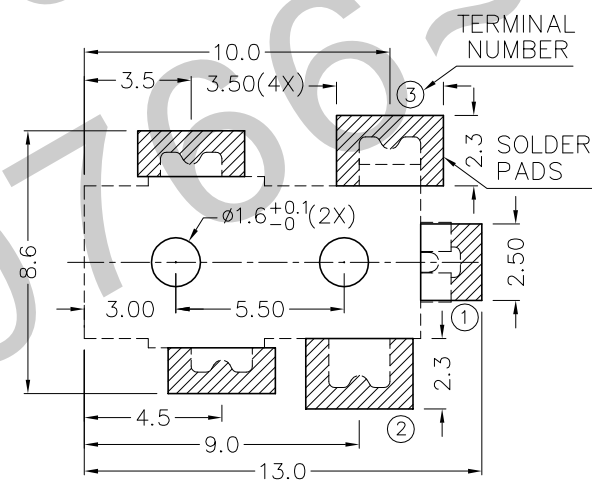
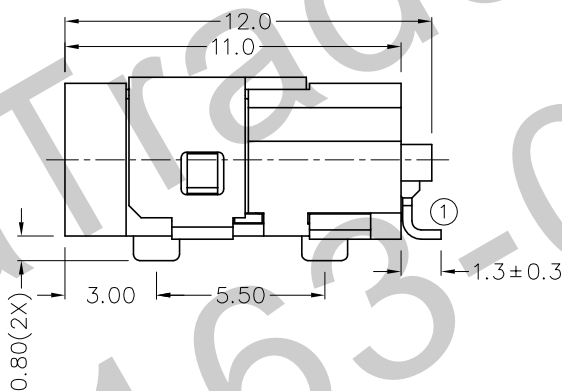
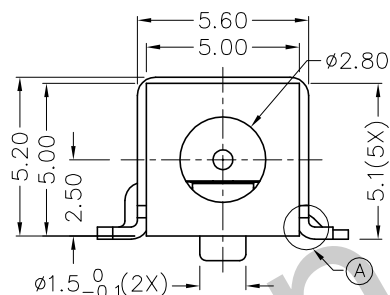
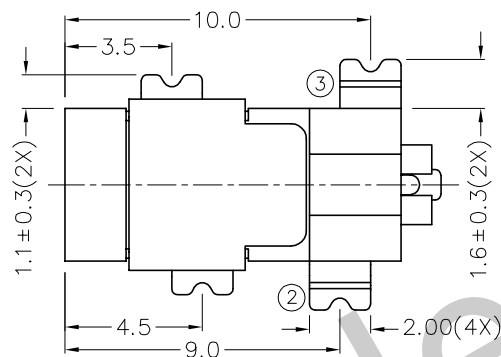
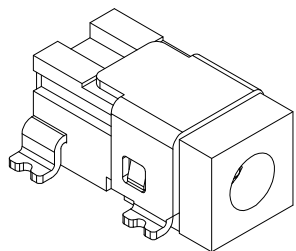

DC MATE PLUG

MODEL NO.	TDC-051DHS
SCHEMATIC	1 3 2
CENTER PIN	φ0.65mm

\* MATERIAL

- TERMINAL 1 : BRASS
- TERMINAL 2 : COPPER ALLOY
- TERMINAL 3 : BRASS
- SHIELD : COLD ROLLED STEEL
- HOUSING : PA6T

RECOMMENDED  
SOLDER PAD LAYOUT  
(TOP VIEW)



TECHNIK INDUSTRIAL CO. LTD.

PART NAME	HIGH CURRENT SMD DC POWER SOCKET	TOLERANCE UNLESS	0.0±0.2	UNIT:	mm	DESIGN	T.Y.LI	DATE	26-7-2004	SCALE	4:1
PART NO.	TDC-051DHS	OTHERWISE SPECIFIED:	0.00±0.1 0.000±0.05			DRAWING	T.Y.LI	DATE	27-4-2010	MATERIAL	*
						CHECK		DATE		DWG. NO.	TZ\DC051DHS-PA6T/C
						APPROVAL		DATE		SHEET	

F

E

D

C

B

A