

F

E

D

C

B

A

RoHS
Compliant

ZONE	SYMBOL	REVISION	APPROVAL	DATE
		ADDED INDICATION OF COPLANARITY	J.X.KUANG	28-4-2010

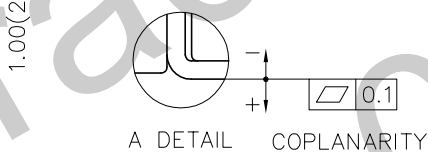
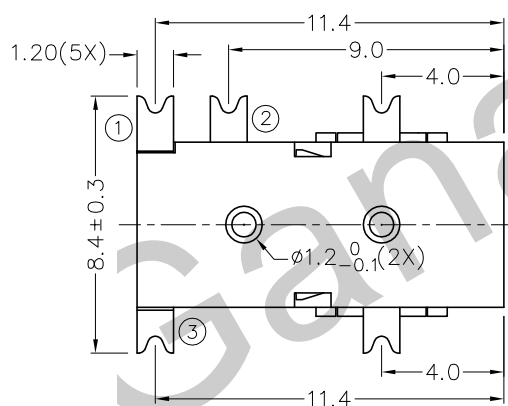
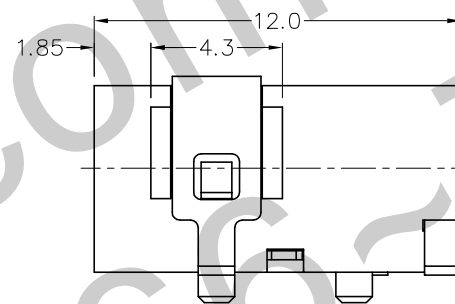
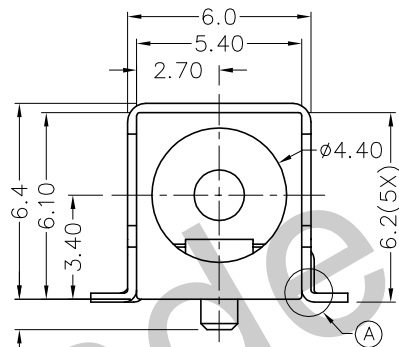
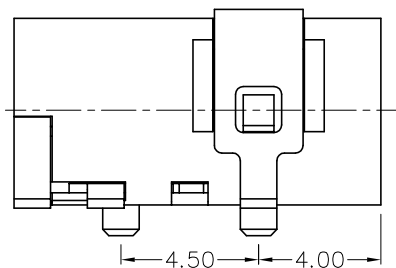
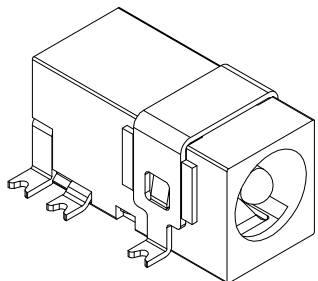

* MATERIAL

- TERMINAL 1 : BRASS
- TERMINAL 2 : COPPER ALLOY
- TERMINAL 3 : BRASS
- SHIELD : BRASS
- HOUSING : PA6T

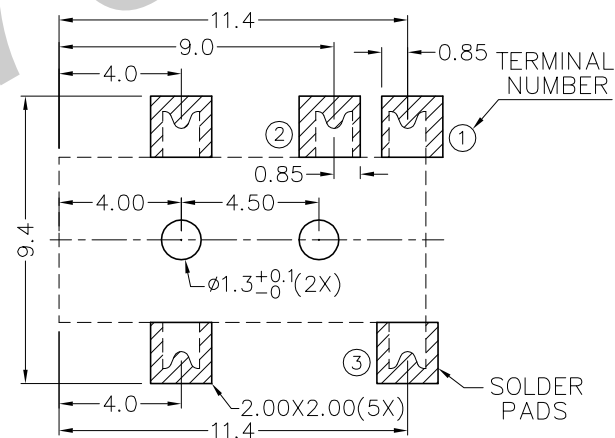

MODEL NO.	TDC-059DS
SCHEMATIC	
CENTER PIN	ø1.65mm

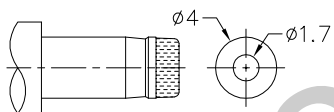

DC MATE PLUG



TECHNIK INDUSTRIAL CO. LTD.

PART NAME	SMD DC POWER SOCKET	TOLERANCE UNLESS 0.0±0.2 0.00±0.1 OTHERWISE SPECIFIED: 0.000±0.05	UNIT: mm	DESIGN	J.X.KUANG	DATE	18-9-2004	SCALE	4:1
				DRAWING	T.Y.LI	DATE	28-4-2010	MATERIAL	*
PART NO.	TDC-059DS			CHECK		DATE		DWG. NO.	TZ\DC059DS-PA6T/C
				APPROVAL		DATE		SHEET	

F

E

D

C

B

A