

F

E

D

C

B

A

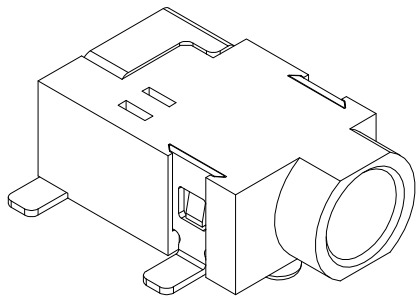

RoHS
Compliant

ZONE	SYMBOL	REVISION	APPROVAL	DATE
		ADDED INDICATION OF COPLANARITY	J.X.KUANG	29-4-2010

1

1

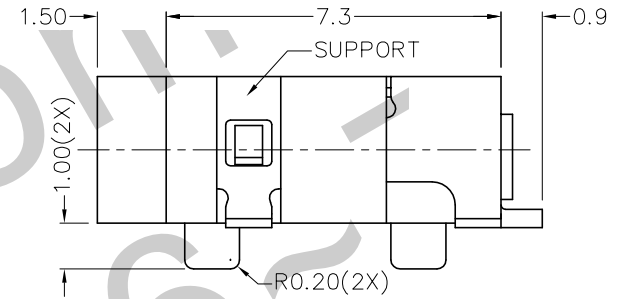
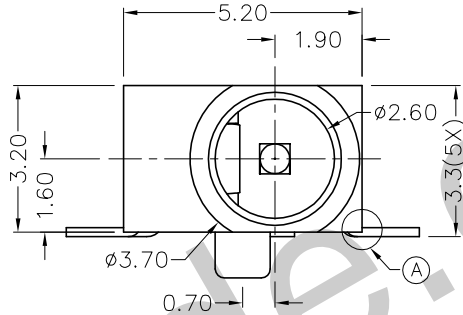
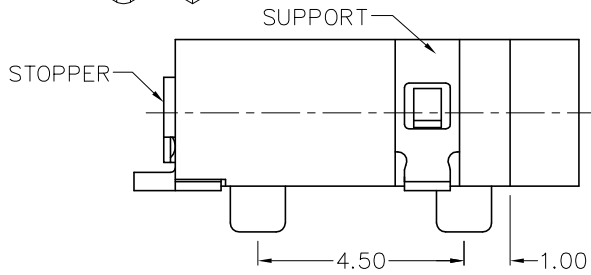

2

2

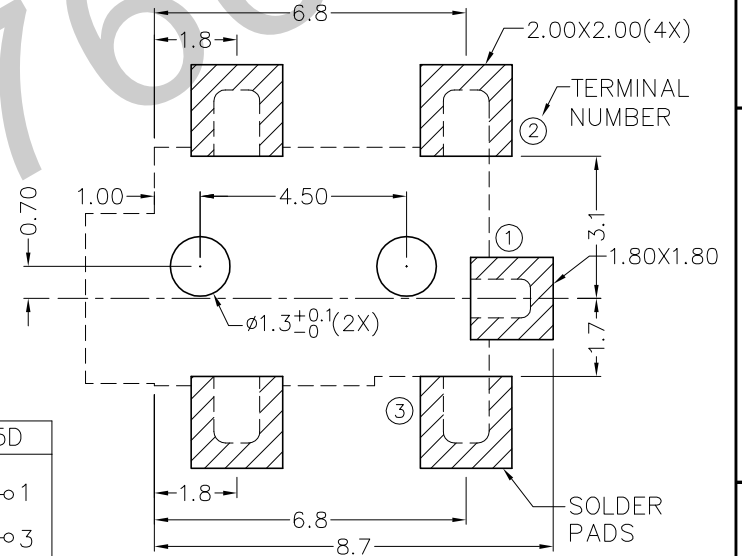
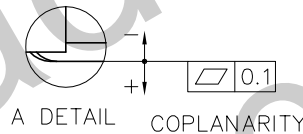
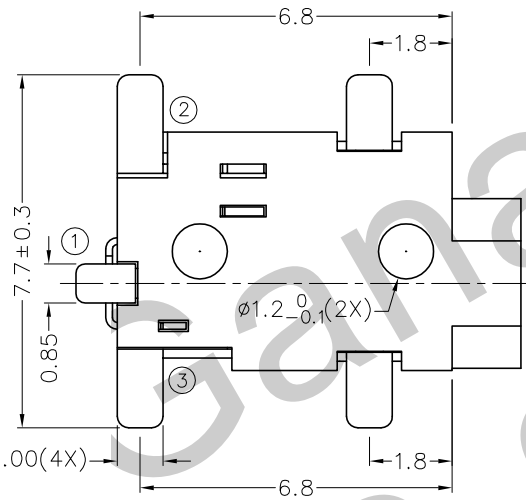

3

3

* MATERIAL

- TERMINAL 1 : BRASS
- TERMINAL 2 : COPPER ALLOY
- TERMINAL 3 : BRASS
- SUPPORT : BRASS
- STOPPER : STAINLESS STEEL
- HOUSING : PA6T

MODEL NO.	TDC-065D
SCHEMATIC	
CENTER PIN	φ0.65mm

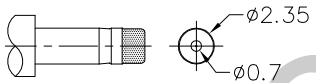

DC MATE PLUG

4

4



TECHNIK INDUSTRIAL CO.LTD.

DESIGN	T.Y.LI	DATE	28-2-2006	SCALE	6:1
DRAWING	T.Y.LI	DATE	29-4-2010	MATERIAL	*
CHECK		DATE		DWG. NO.	TZ\DC065D-PA6T/B
APPROVAL		DATE		SHEET	

PART NAME	SMD DC POWER SOCKET	TOLERANCE UNLESS	0.0±0.2	UNIT:	mm
PART NO.	TDC-065D	OTHERWISE SPECIFIED:	0.00±0.1 0.000±0.05		

F

E

D

C

B

A