

F

E

D

C

B

A

ZONE	SYMBOL	REVISION	APPROVAL	DATE

RoHS
Compliant

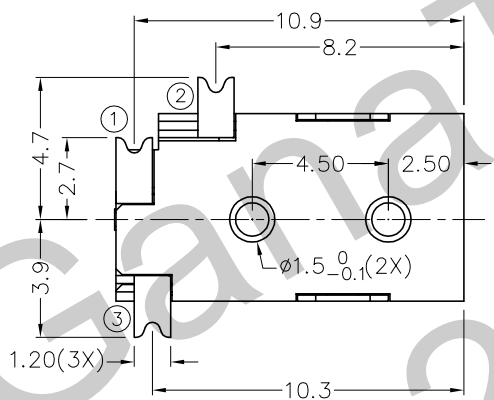
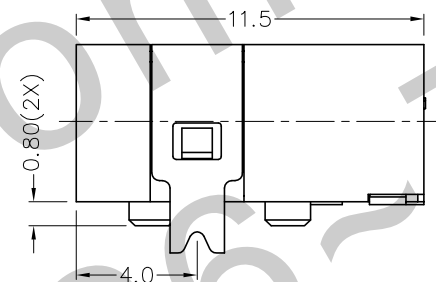
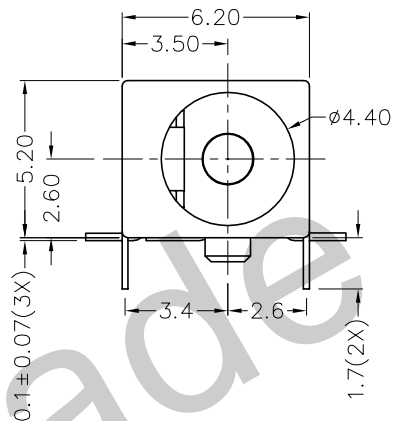
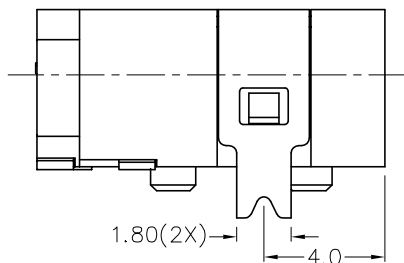
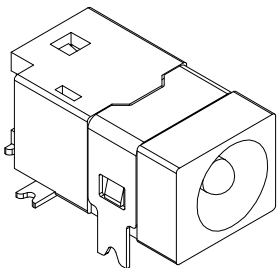

* MATERIAL

TERMINAL 1 : BRASS
 TERMINAL 2 : COPPER ALLOY
 TERMINAL 3 : BRASS
 SHIELD : COPPER ALLOY
 HOUSING : PA6T

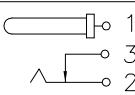
MODEL NO.	TDC-068DS2
SCHEMATIC	
CENTER PIN	$\phi 1.65\text{mm}$

0.70X2.30(2X)

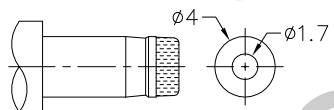
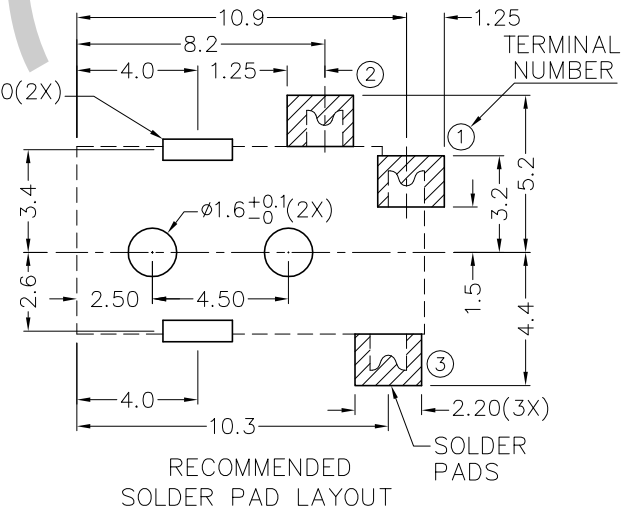

DC MATE PLUG



TECHNIK INDUSTRIAL CO.LTD.

DESIGN	T.Y.LI	DATE	20-10-2006	SCALE	4:1
DRAWING	T.Y.LI	DATE	20-6-2008	MATERIAL	*
CHECK		DATE		DWG. NO.	TZ\DC068DS2-PA6T/A
APPROVAL		DATE		SHEET	

PART NAME SMD DC POWER SOCKET

TOLERANCE UNLESS
 0.0±0.2
 0.00±0.1
 OTHERWISE SPECIFIED: 0.000±0.05

UNIT: mm



F

E

D

C

B

A