

F

E

D

C

B

A

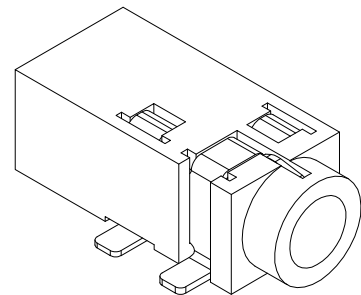

RoHS
Compliant

ZONE	SYMBOL	REVISION	APPROVAL	DATE
		ADDED INDICATION OF COPLANARITY	J.X.KUANG	22-12-2008

1

1

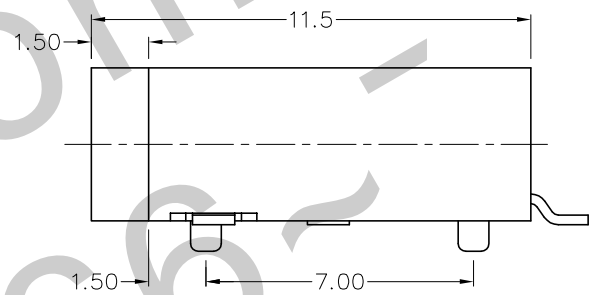
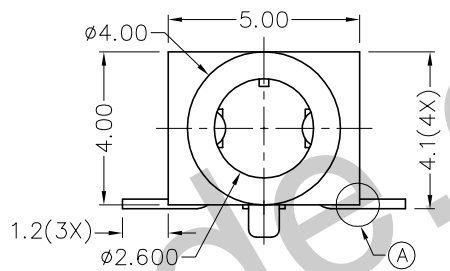
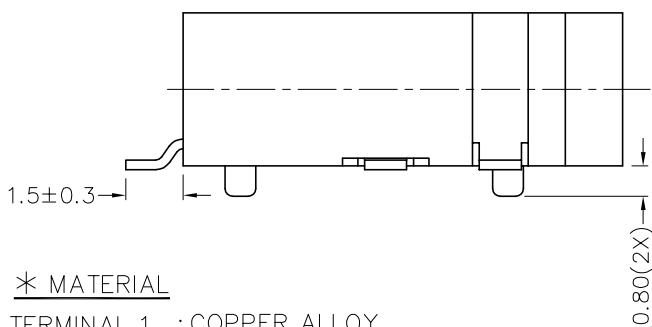

2

2

* MATERIAL

- TERMINAL 1 : COPPER ALLOY
- TERMINAL 2 : COPPER ALLOY
- TERMINAL 3 : COPPER ALLOY
- TERMINAL 4 : COPPER ALLOY
- HOUSING : PA6T

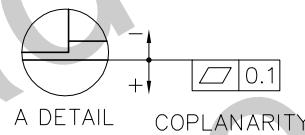

MODEL NO.	TG-2684	TG-2683	TG-2682
SCHEMATIC			

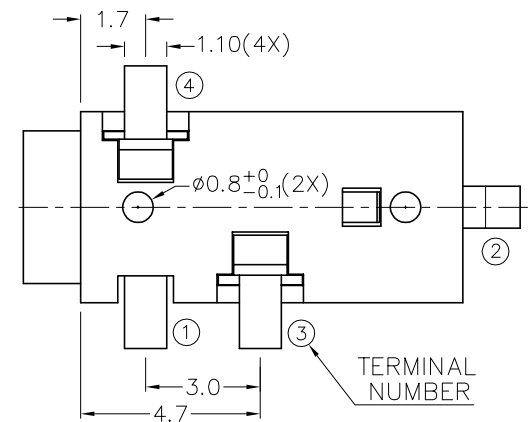
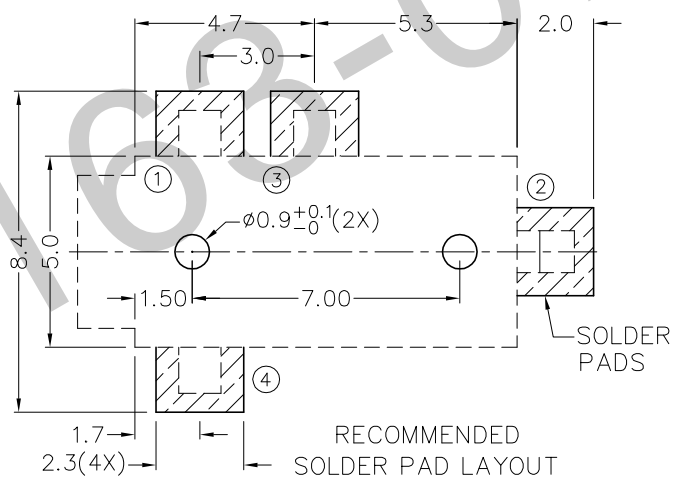

3

3

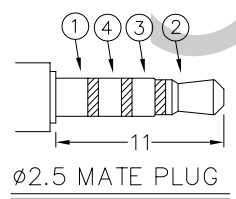

4

4



TECHNIK INDUSTRIAL CO. LTD.

DESIGN	J.X.KUANG	DATE	1-10-2003	SCALE	5:1
DRAWING	T.Y.LI	DATE	22-12-2008	MATERIAL	*
CHECK		DATE		DWG. NO.	TZ\TG268-PA6T/D
APPROVAL		DATE		SHEET	

PART NAME	2.5mm SMD STEREO JACK	TOLERANCE UNLESS	0.0±0.2	UNIT:	mm
PART NO.	TG-268	OTHERWISE SPECIFIED:	0.00±0.1 0.000±0.05		

F

E

D

C

B

A