

F

E

D

C

B

A

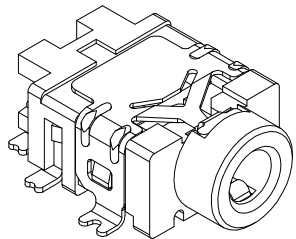

RoHS
Compliant

ZONE	SYMBOL	REVISION	APPROVAL	DATE
F2	△	TERMINAL 11 MODIFIED	J.X.KUANG	7-2-2009

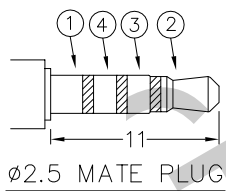
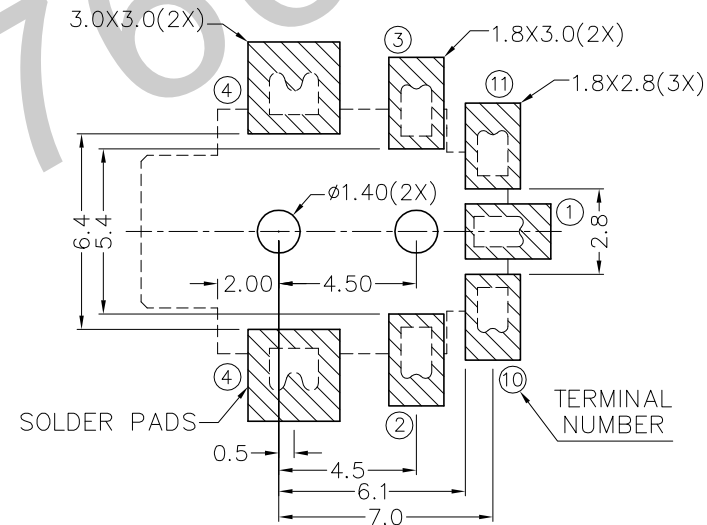
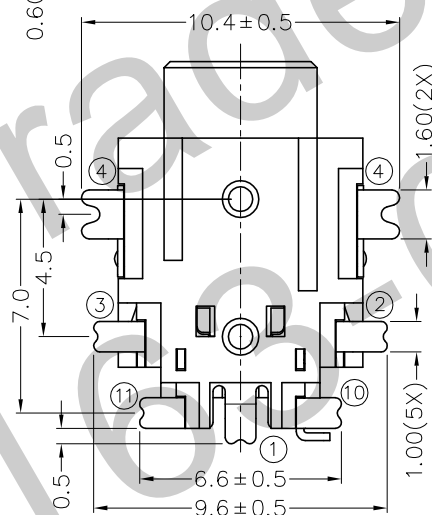
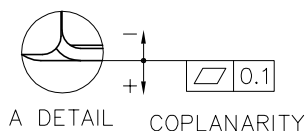
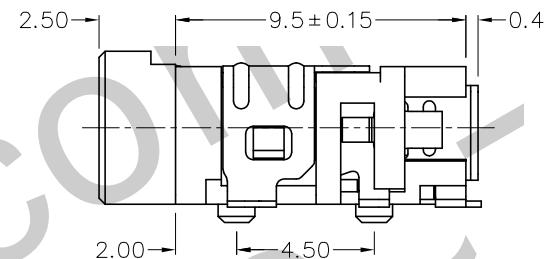
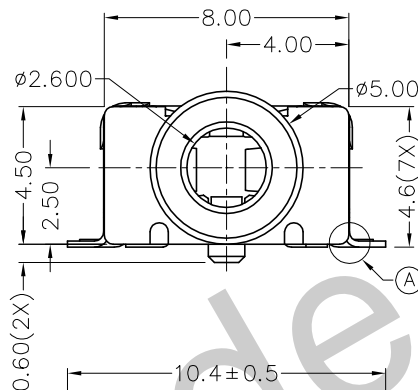
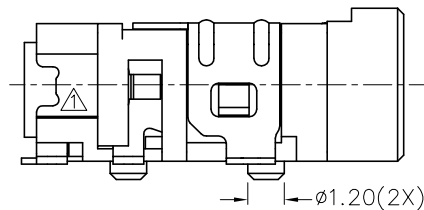

* MATERIAL

- TERMINAL 1 : COPPER ALLOY
- TERMINAL 2 : COPPER ALLOY
- TERMINAL 3 : COPPER ALLOY
- TERMINAL 4 : COPPER ALLOY
- TERMINAL 10 : BRASS
- TERMINAL 11 : BRASS
- HOUSING : PA6T

MODEL NO.	TG-2706D	TG-2705AD	TG-2705BD	TG-2705D	TG-2704D
SCHEMATIC					



TECHNIK INDUSTRIAL CO. LTD.

DESIGN	T.Y.LI	DATE	6-4-2004	SCALE	4:1
DRAWING	T.Y.LI	DATE	7-2-2009	MATERIAL	*
CHECK		DATE		DWG. NO.	TZ\TG270D-PA6T/E
APPROVAL		DATE		SHEET	

PART NAME	2.5mm SMD STEREO JACK	TOLERANCE UNLESS	0.0±0.2	UNIT:	
PART NO.	TG-270D	OTHERWISE SPECIFIED:	0.00±0.1 0.000±0.05	mm	

F

E

D

C

B

A