

F

E

D

C

B

A

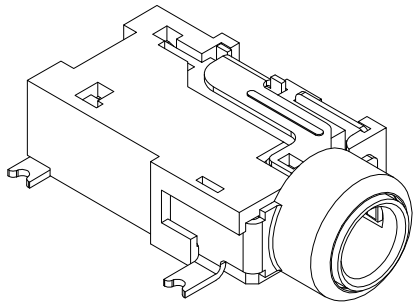

RoHS  
Compliant

ZONE	SYMBOL	REVISION	APPROVAL	DATE
		ADDED INDICATION OF COPLANARITY	J.X.KUANG	25-12-2008

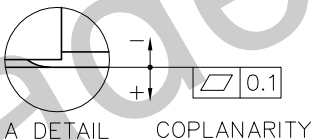
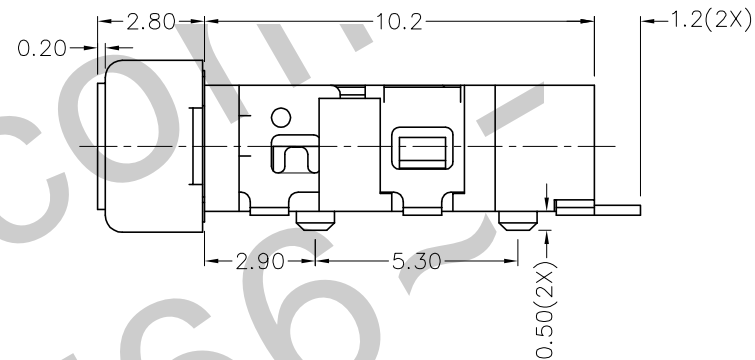
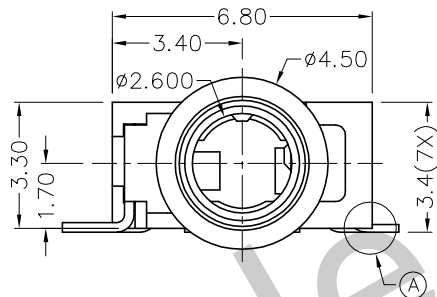
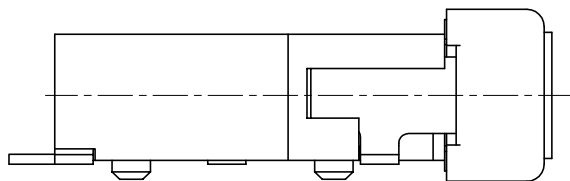

\* MATERIAL

- TERMINAL 1 : BRASS
- TERMINAL 2 : COPPER ALLOY
- TERMINAL 3 : COPPER ALLOY
- TERMINAL 4 : COPPER ALLOY
- TERMINAL 5 : COPPER ALLOY
- TERMINAL 10 : BRASS
- TERMINAL 11 : BRASS
- HOUSING : PA6T

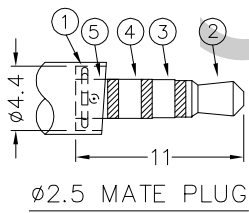
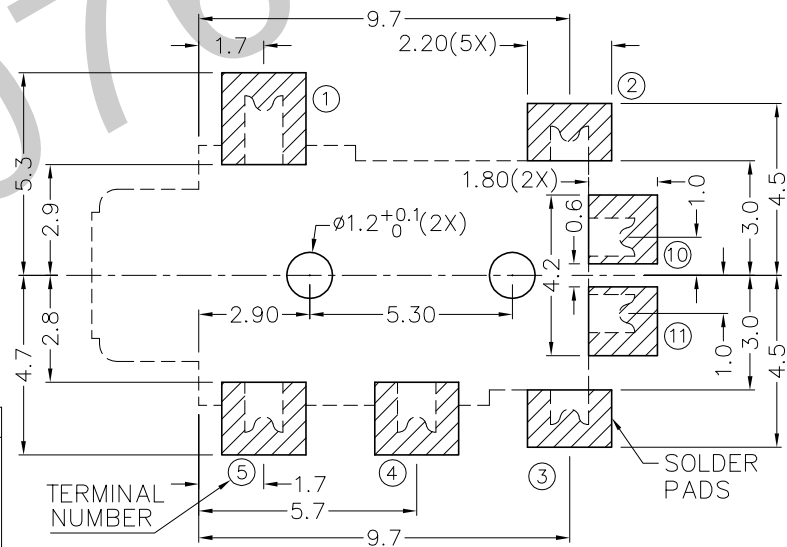
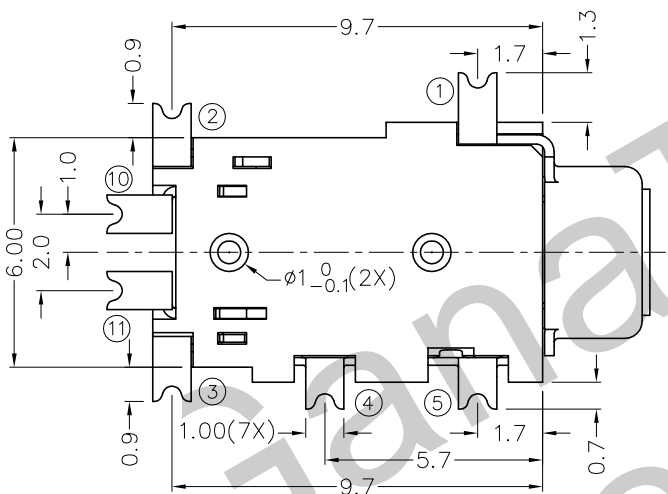

MODEL NO.	TG-2887D	TG-2886AD	TG-2886BD	TG-2885D
SCHMATIC				



TECHNIK INDUSTRIAL CO. LTD.

DESIGN	J.X.KUANG	DATE	15-7-2004	SCALE	5:1
DRAWING	T.Y.LI	DATE	25-12-2008	MATERIAL	*
CHECK		DATE		DWG. NO.	TZ\TG288D-PA6T/C
APPROVAL		DATE		SHEET	

PART NAME	2.5mm SMD STEREO JACK	TOLERANCE UNLESS	0.0±0.2	UNIT:	mm
PART NO.	TG-288D	OTHERWISE SPECIFIED:	0.00±0.1 0.000±0.05		

F

E

D

C

B

A