

F

E

D

C

B

A

RoHS
Compliant

ZONE	SYMBOL	REVISION	APPROVAL	DATE
		ADD MODEL NO.	J.X.KUANG	1-4-2009

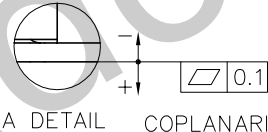
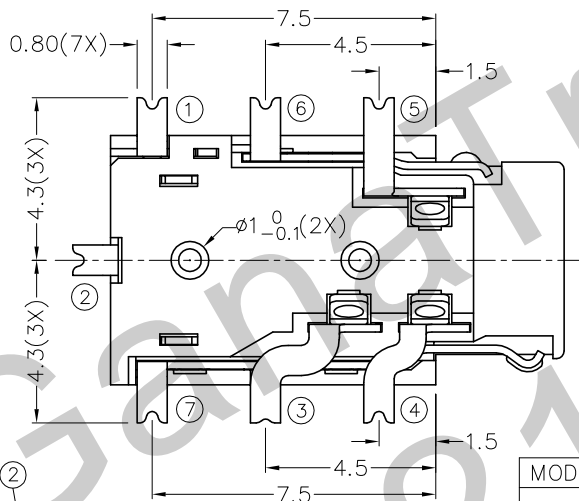
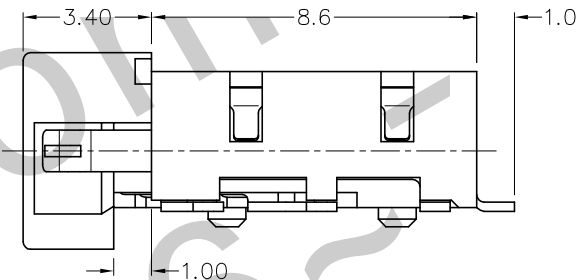
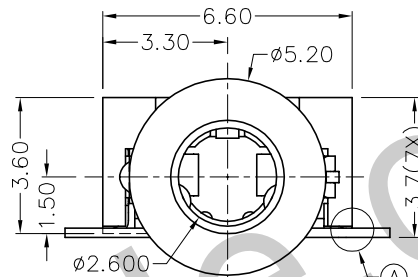
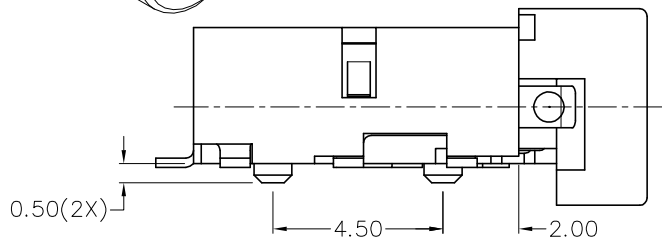
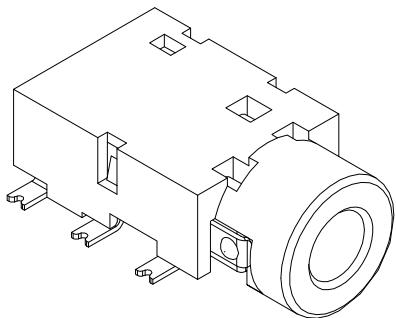

* MATERIAL

- TERMINAL 1 : COPPER ALLOY
- TERMINAL 2 : COPPER ALLOY
- TERMINAL 3 : COPPER ALLOY
- TERMINAL 4 : COPPER ALLOY
- TERMINAL 5 : COPPER ALLOY
- TERMINAL 6 : COPPER ALLOY
- TERMINAL 7 : COPPER ALLOY
- HOUSING : PA6T

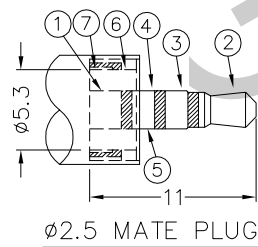
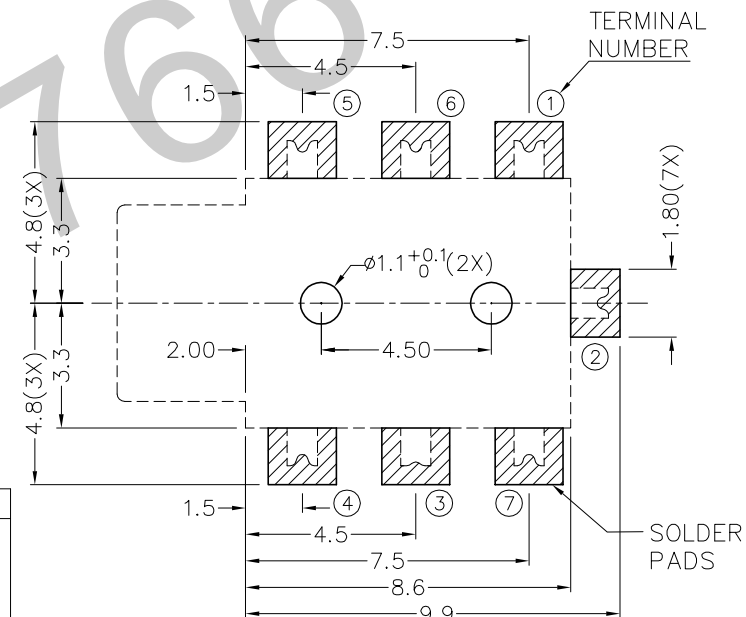

MODEL NO.	TG-4067D	TG-4065D
SCHEMATIC		



TECHNIK INDUSTRIAL CO.LTD.

DESIGN	G.P.YI	DATE	21-1-2008	SCALE	5:1
DRAWING	T.Y.LI	DATE	1-4-2009	MATERIAL	*
CHECK		DATE		DWG. NO.	TZ\TG406D-PA6T/C
APPROVAL		DATE		SHEET	

PART NAME	2.5mm SMD STEREO JACK	TOLERANCE UNLESS	0.0±0.2	UNIT:	
PART NO.	TG-406D	OTHERWISE SPECIFIED:	0.00±0.1 0.000±0.05	mm	

F

E

D

C

B

A