

RoHS
Compliant

ZONE	SYMBOL	REVISION	APPROVAL	DATE

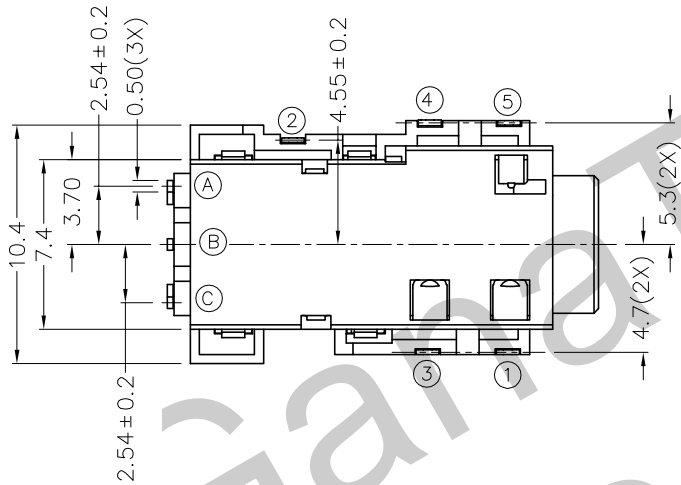
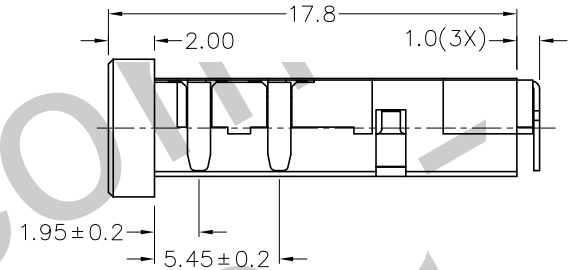
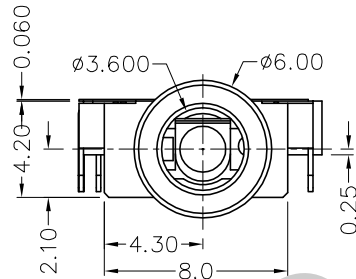
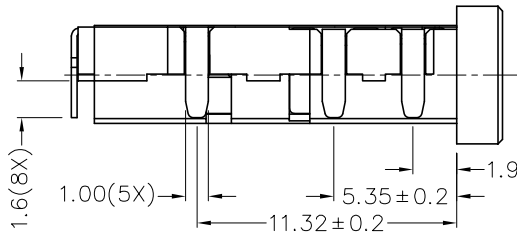

* MATERIAL

- TERMINAL 1 : COPPER ALLOY
- TERMINAL 2 : COPPER ALLOY
- TERMINAL 3 : COPPER ALLOY
- TERMINAL 4 : COPPER ALLOY
- TERMINAL 5 : COPPER ALLOY
- SPRING : STAINLESS STEEL
- HOUSING : PA9T
- COVER : PA9T
- TAPE : POLYIMIDE
- DRIVE IC :

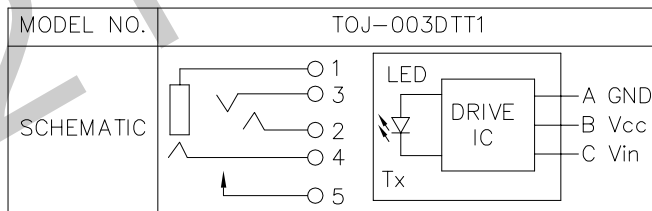
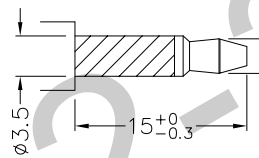
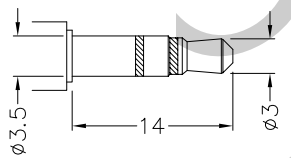
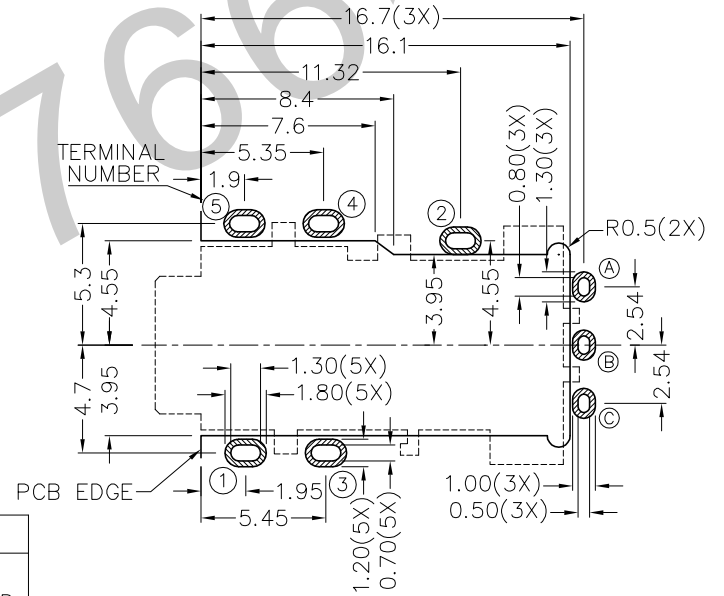

PCB LAYOUT
(TOP VIEW)



TECHNIK INDUSTRIAL CO.LTD.

DESIGN	H.L.TAN	DATE	9-10-2009	SCALE	3:1
DRAWING	X.N.ZHENG	DATE	7-12-2009	MATERIAL	*
CHECK		DATE		DWG. NO.	TZ\0J003DTT1-PA9T/A
APPROVAL		DATE		SHEET	

PART NAME	3.5mm SMD STEREO JACK/OPTO	TOLERANCE UNLESS	0.0±0.2	UNIT:	mm
PART NO.	TOJ-003DTT1	OTHERWISE SPECIFIED:	0.00±0.1 0.000±0.05		

F E D C B A