

F

E

D

C

B

A

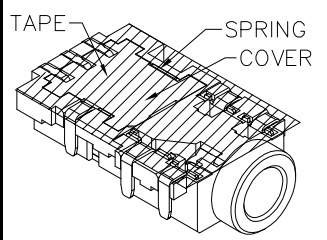

RoHS
Compliant

ZONE	SYMBOL	REVISION	APPROVAL	DATE

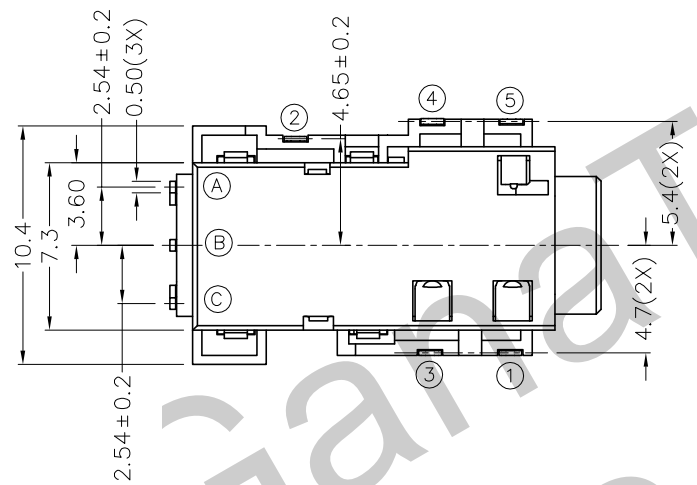
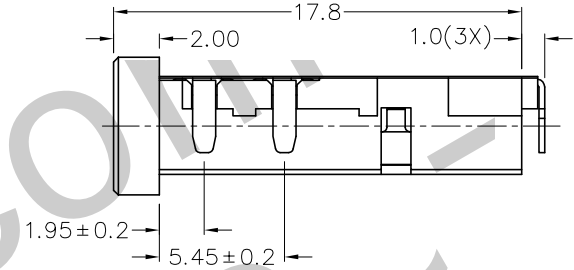
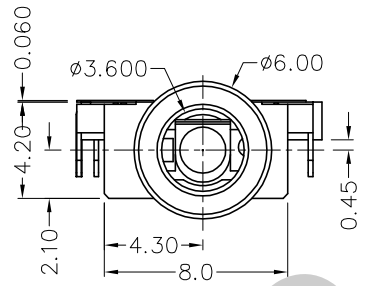
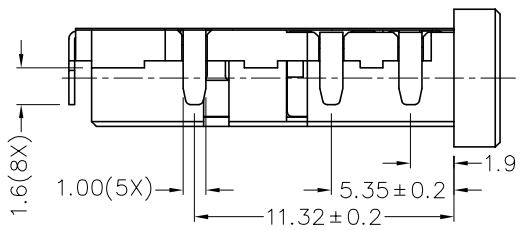

- * MATERIAL**
- TERMINAL 1 : COPPER ALLOY
 - TERMINAL 2 : COPPER ALLOY
 - TERMINAL 3 : COPPER ALLOY
 - TERMINAL 4 : COPPER ALLOY
 - TERMINAL 5 : COPPER ALLOY
 - SPRING : STAINLESS STEEL
 - HOUSING : PA9T
 - COVER : PA9T
 - TAPE : POLYIMIDE
 - DRIVE IC :

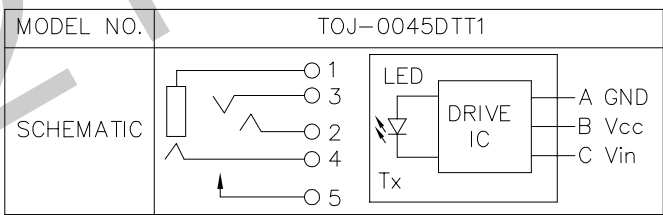
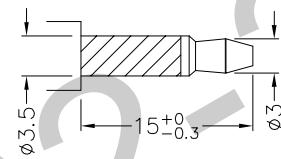
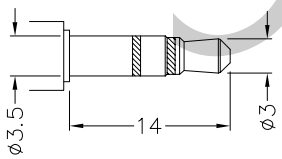
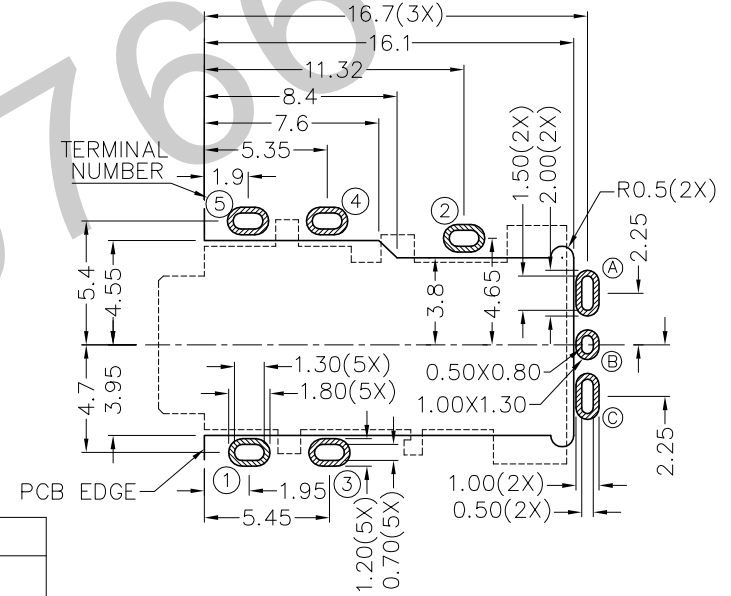

TECHNIK INDUSTRIAL CO. LTD.

DESIGN	X.N.ZHENG	DATE	21-10-2009	SCALE	3:1
DRAWING	X.N.ZHENG	DATE	3-12-2009	MATERIAL	*
CHECK		DATE		DWG. NO.	TZ\QJ004DTT1-PA9T/A
APPROVAL		DATE		SHEET	

PART NAME	3.5mm SMD STEREO JACK/OPTO	TOLERANCE UNLESS	0.0±0.2	UNIT:	mm
PART NO.	TOJ-004DTT1	OTHERWISE SPECIFIED:	0.00±0.1 0.000±0.05		

F

E

D

C

B

A