

F

E

D

C

B

A

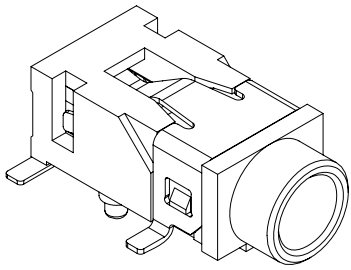

RoHS
Compliant

ZONE	SYMBOL	REVISION	APPROVAL	DATE
		DESIGN CHANGED	J.X.KUANG	6-1-2012

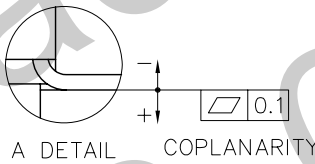
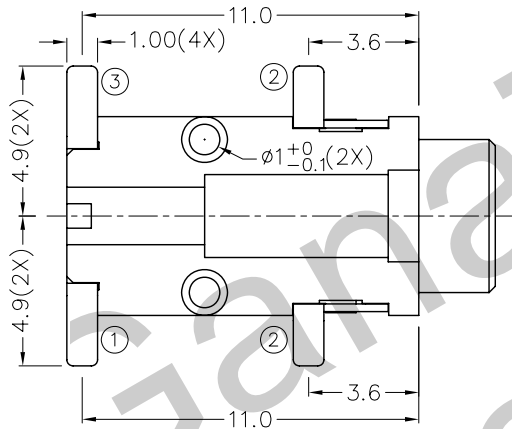
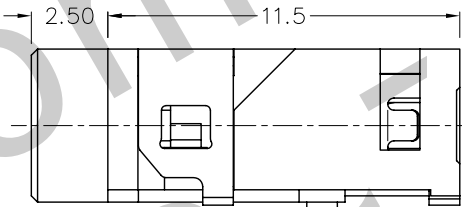
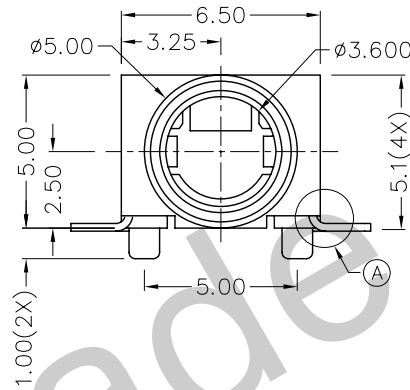
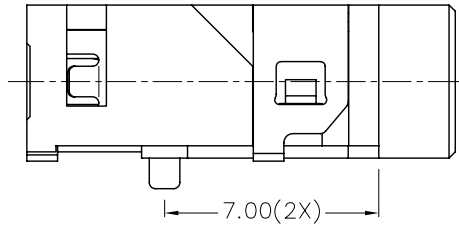

* MATERIAL

- TERMINAL 1 : COPPER ALLOY
- TERMINAL 2 : COPPER ALLOY
- TERMINAL 3 : COPPER ALLOY
- HOUSING : PA6T

MODEL NO.	TSH-3733D
SCHEMATIC	

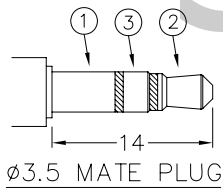
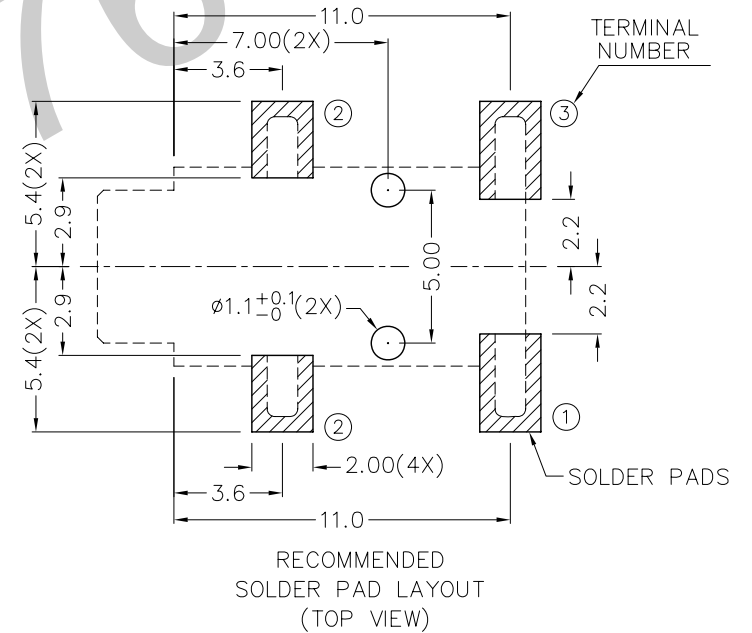

TECHNIK INDUSTRIAL CO. LTD.

PART NAME 3.5mm SMD STEREO JACK
PART NO. TSH-373D

TOLERANCE UNLESS 0.0±0.2
OTHERWISE SPECIFIED: 0.00±0.1
0.00±0.05

UNIT: mm

DESIGN	J.JIANG	DATE	3-5-2004	SCALE	4:1
DRAWING	CH.XIONG	DATE	6-1-2012	MATERIAL	*
CHECK		DATE		DWG. NO.	TZ\SH373D-PA6T/E
APPROVAL		DATE		SHEET	

F

E

D

C

B

A