

F

E

D

C

B

A

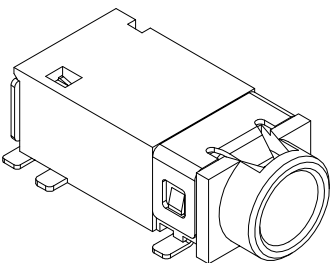

RoHS
Compliant

ZONE	SYMBOL	REVISION	APPROVAL	DATE
		ADDED INDICATION OF COPLANARITY	J.X.KUANG	28-11-2008

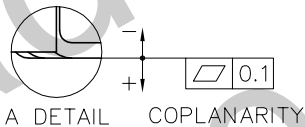
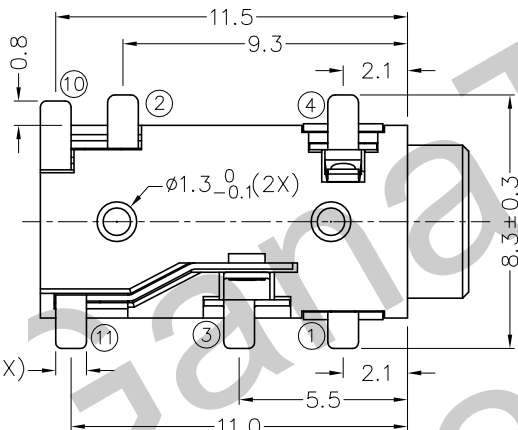
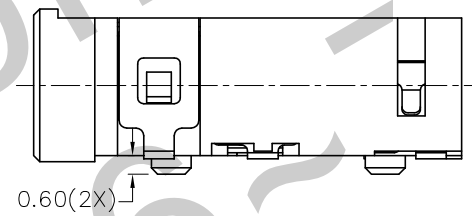
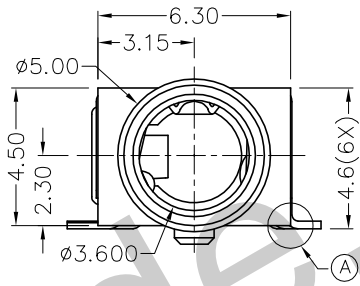
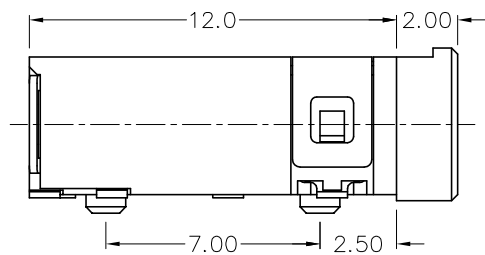

- * MATERIAL
- TERMINAL 1 : COPPER ALLOY
 - TERMINAL 2 : COPPER ALLOY
 - TERMINAL 3 : COPPER ALLOY
 - TERMINAL 4 : COPPER ALLOY
 - TERMINAL 10 : BRASS
 - TERMINAL 11 : BRASS
 - HOUSING : PA6T

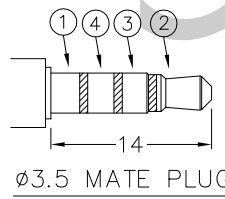
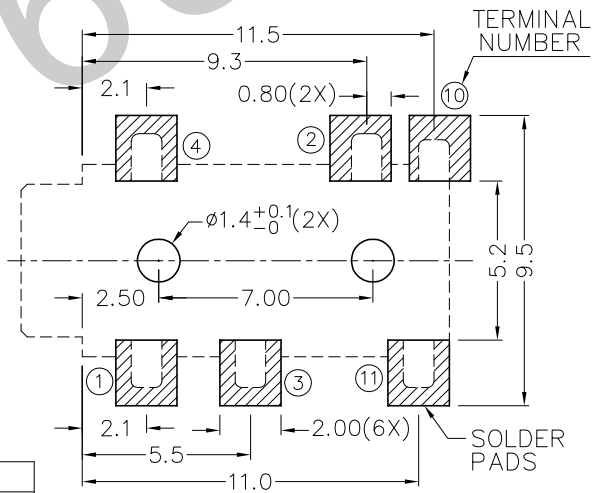

MODEL NO.	TSH-3896D	TSH-3895AD	TSH-3895BD	TSH-3894D
SCHEMATIC				



TECHNIK INDUSTRIAL CO. LTD.

DESIGN	T.Y.LI	DATE	17-10-2005	SCALE	4:1
DRAWING	T.Y.LI	DATE	28-11-2008	MATERIAL	*
CHECK		DATE		DWG. NO.	TZ\SH389D-PA6T/D
APPROVAL		DATE		SHEET	

PART NAME	3.5mm SMD STEREO JACK	TOLERANCE UNLESS	0.0±0.2	UNIT:	mm
PART NO.	TSH-389D	OTHERWISE SPECIFIED:	0.00±0.1 0.000±0.05		

F

E

D

C

B

A