

F

E

D

C

B

A

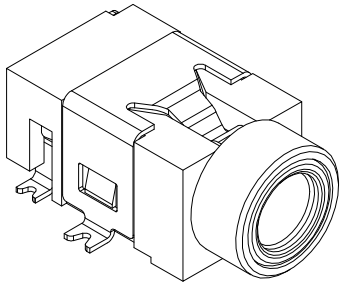

RoHS  
Compliant

ZONE	SYMBOL	REVISION	APPROVAL	DATE
		ADDED INDICATION OF COPLANARITY	J.X.KUANG	1-12-2008

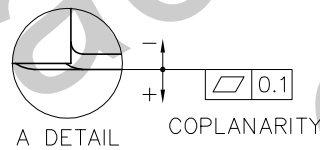
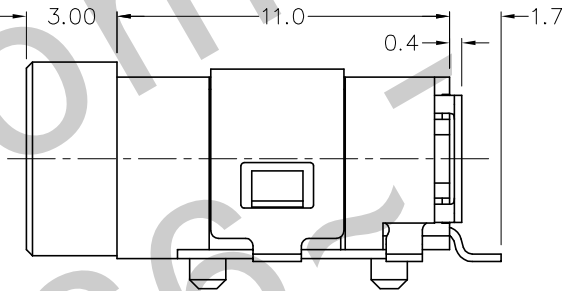
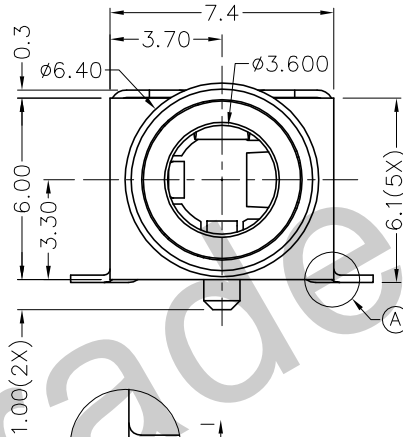
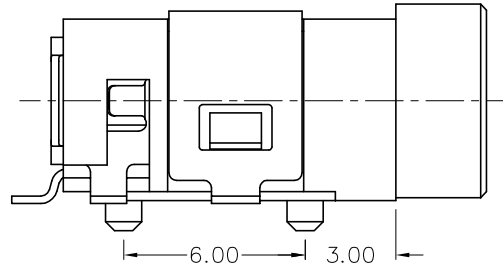

\* MATERIAL

TERMINAL 1 : COPPER ALLOY  
 TERMINAL 2 : COPPER ALLOY  
 TERMINAL 3 : COPPER ALLOY  
 TERMINAL 4 : COPPER ALLOY  
 BUSHING : BRASS  
 HOUSING : PA6T

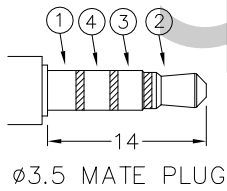
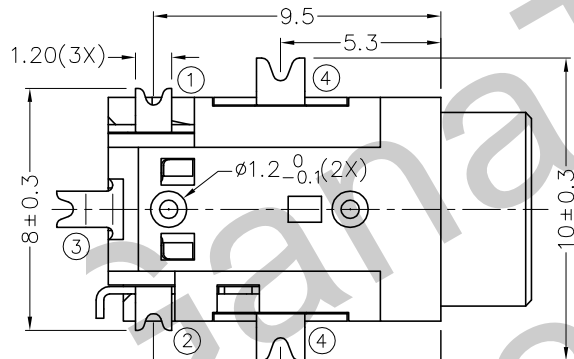
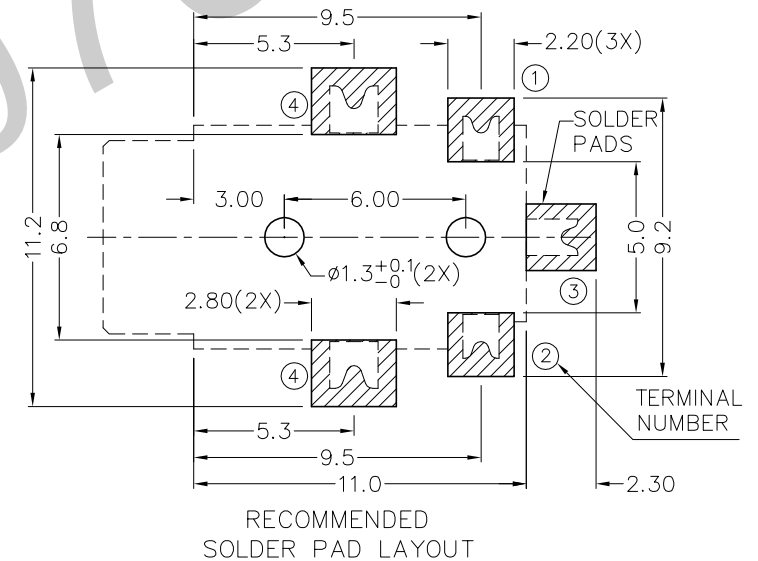

MODEL NO.	TSH-3944DM	TSH-3943DM
SCHEMATIC		



TECHNIK INDUSTRIAL CO.LTD.

DESIGN	T.Y.LI	DATE	10-10-2006	SCALE	4:1
DRAWING	T.Y.LI	DATE	1-12-2008	MATERIAL	*
CHECK		DATE		DWG. NO.	TZ\SH394DM-PA6T/C
APPROVAL		DATE		SHEET	

PART NAME	3.5mm SMD STEREO JACK	TOLERANCE UNLESS	0.0±0.2	UNIT:	mm
PART NO.	TSH-394DM	OTHERWISE SPECIFIED:	0.00±0.1 0.000±0.05		

F

E

D

C

B

A