

F

E

D

C

B

A

RoHS
Compliant

ZONE	SYMBOL	REVISION	APPROVAL	DATE

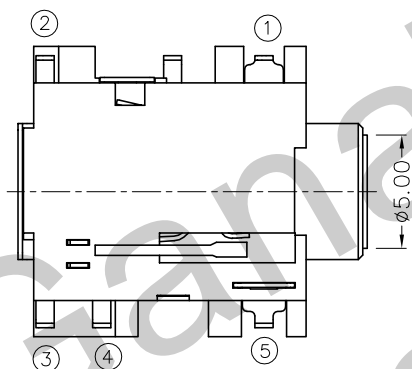
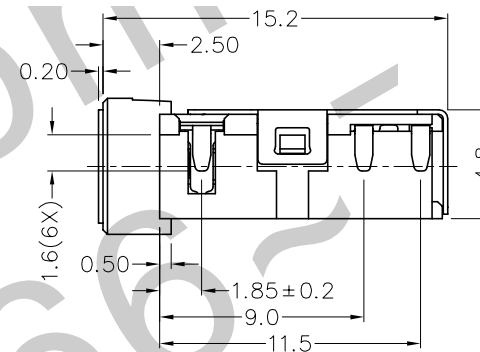
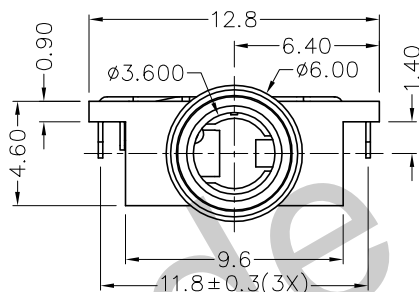
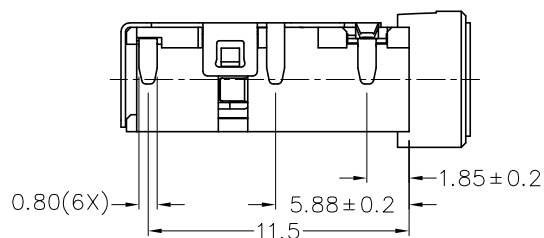
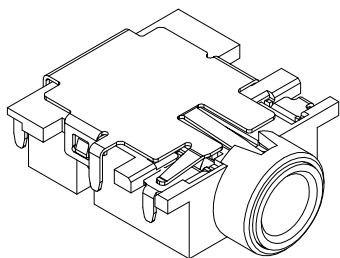

* MATERIAL

TERMINAL 1 : COPPER ALLOY
 TERMINAL 2 : COPPER ALLOY
 TERMINAL 3 : COPPER ALLOY
 TERMINAL 4 : COPPER ALLOY
 TERMINAL 5 : COPPER ALLOY
 SHIELD : COPPER ALLOY
 BUSHING : BRASS
 HOUSING : PA9T

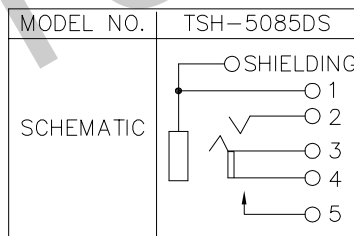
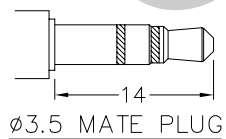
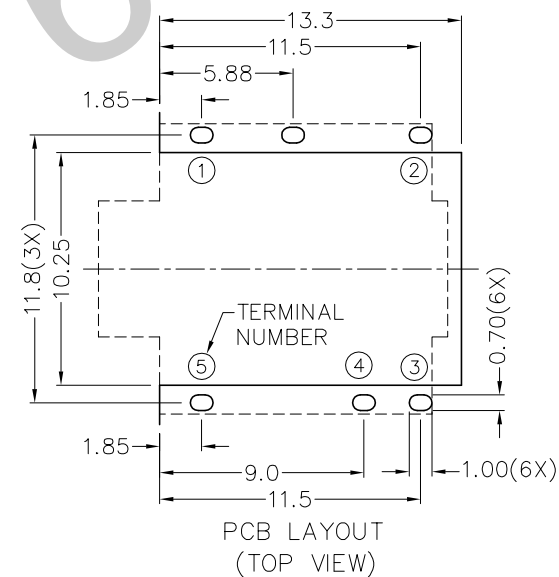

TECHNIK INDUSTRIAL CO.LTD.

DESIGN	T.Y.LI	DATE	9-1-2009	SCALE	3:1
DRAWING	T.Y.LI	DATE	24-2-2009	MATERIAL	*
CHECK		DATE		DWG. NO.	TZ\SH508DS-PA9T/A
APPROVAL		DATE		SHEET	

PART NAME 3.5mm SMD STEREO JACK

TOLERANCE UNLESS 0.0±0.2

UNIT: mm



PART NO. TSH-508DS

OTHERWISE SPECIFIED: 0.00±0.1
0.000±0.05

F

E

D

C

B

A