

F

E

D

C

B

A

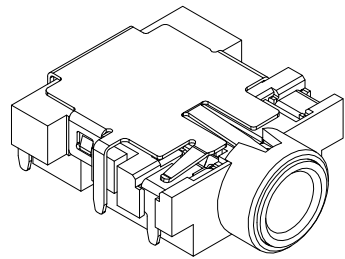

RoHS  
Compliant

ZONE	SYMBOL	REVISION	APPROVAL	DATE

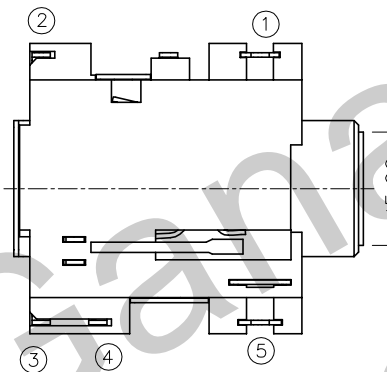
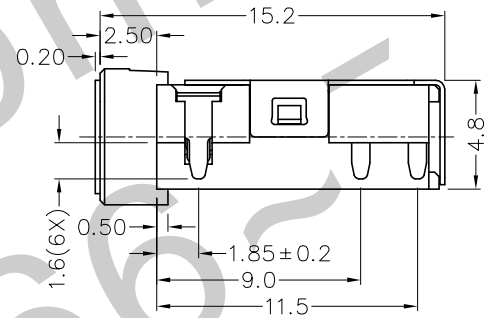
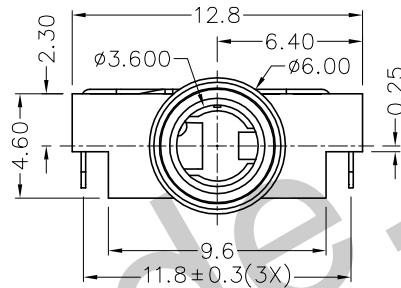
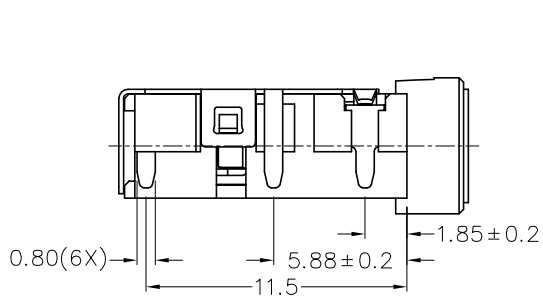

\* MATERIAL

TERMINAL 1 : COPPER ALLOY  
 TERMINAL 2 : COPPER ALLOY  
 TERMINAL 3 : COPPER ALLOY  
 TERMINAL 4 : COPPER ALLOY  
 TERMINAL 5 : COPPER ALLOY  
 SHIELD : COPPER ALLOY  
 BUSHING : BRASS  
 HOUSING : PA9T

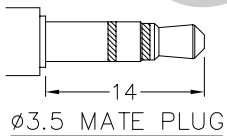
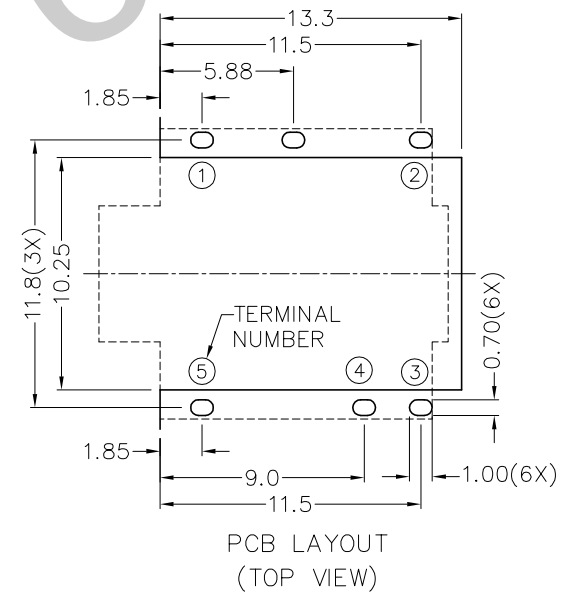
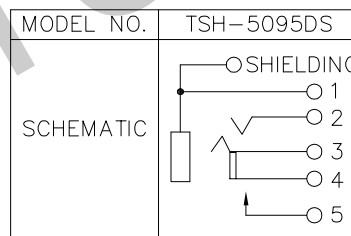

TECHNIK INDUSTRIAL CO.LTD.

DESIGN	T.Y.LI	DATE	10-1-2009	SCALE	3:1
DRAWING	T.Y.LI	DATE	17-2-2009	MATERIAL	*
CHECK		DATE		DWG. NO.	TZ\SH509DS-PA9T/A
APPROVAL		DATE		SHEET	

PART NAME 3.5mm SMD STEREO JACK  
 PART NO. TSH-509DS

TOLERANCE UNLESS 0.0±0.2  
 OTHERWISE SPECIFIED: 0.00±0.1  
 0.000±0.05

UNIT: mm



F

E

D

C

B

A