

F

E

D

C

B

A

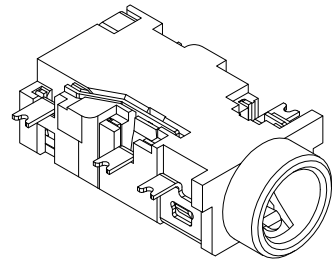

RoHS
Compliant

ZONE	SYMBOL	REVISION	APPROVAL	DATE

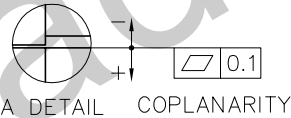
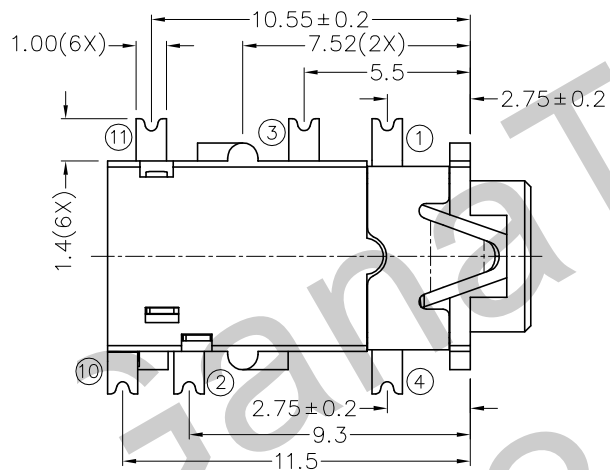
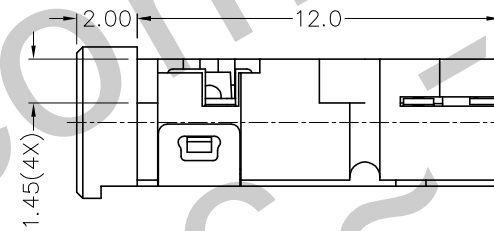
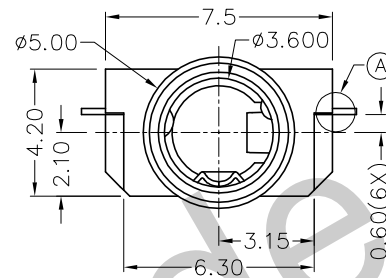
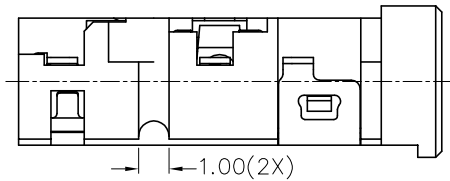

* MATERIAL

TERMINAL 1 : COPPER ALLOY
TERMINAL 2 : COPPER ALLOY
TERMINAL 3 : COPPER ALLOY
TERMINAL 4 : COPPER ALLOY
TERMINAL 10 : COPPER ALLOY
TERMINAL 11 : COPPER ALLOY
HOUSING : PA6T

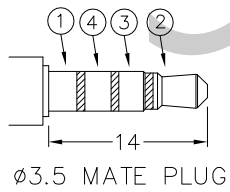
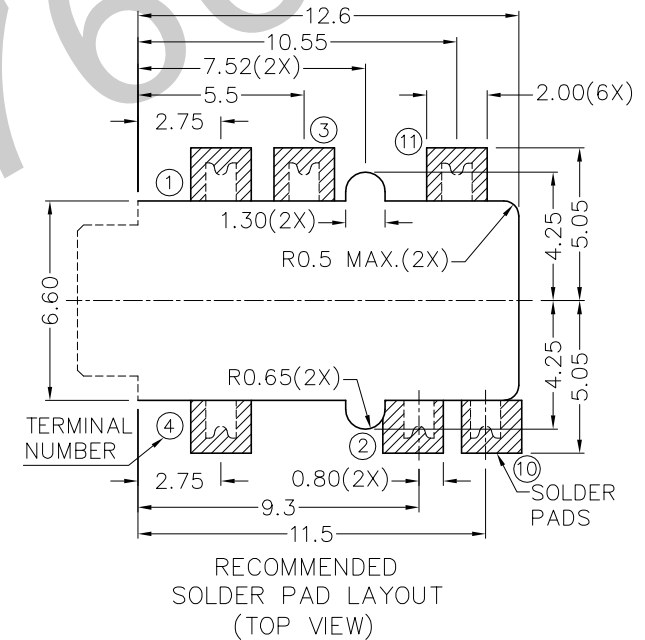

MODEL NO.	TSH-5186D
SCHEMATIC	○ 1
	○ 4
	○ 3
	○ 11
	○ 10
	○ 2



TECHNIK INDUSTRIAL CO.LTD.

DESIGN	T.Y.LI	DATE	10-7-2009	SCALE	4:1
DRAWING	T.Y.LI	DATE	10-7-2009	MATERIAL	*
CHECK		DATE		DWG. NO.	TZ\SH518D-PA6T/A
APPROVAL		DATE		SHEET	

PART NAME 3.5mm SMD STEREO JACK

TOLERANCE UNLESS 0.0±0.2
OTHERWISE SPECIFIED: 0.00±0.1
0.000±0.05

UNIT: mm



F

E

D

C

B

A