

F

E

D

C

B

A

RoHS
Compliant

ZONE	SYMBOL	REVISION	APPROVAL	DATE

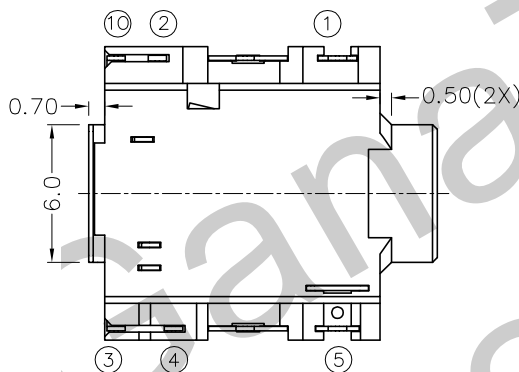
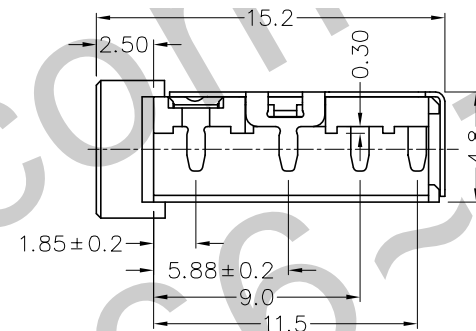
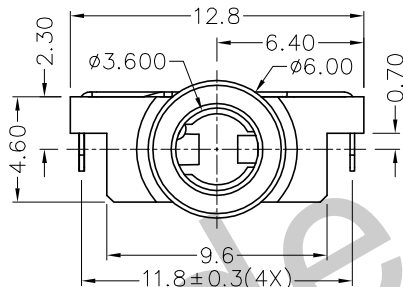
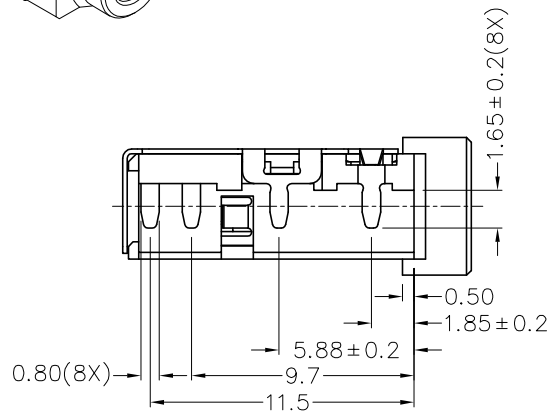
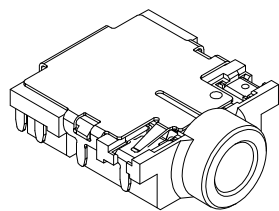

* MATERIAL

- TERMINAL 1 : COPPER ALLOY
- TERMINAL 2 : COPPER ALLOY
- TERMINAL 3 : COPPER ALLOY
- TERMINAL 4 : COPPER ALLOY
- TERMINAL 5 : COPPER ALLOY
- TERMINAL 10: COPPER ALLOY
- SHIELD : COPPER ALLOY
- HOUSING : PA6T

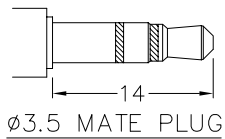
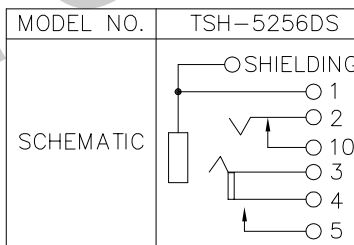
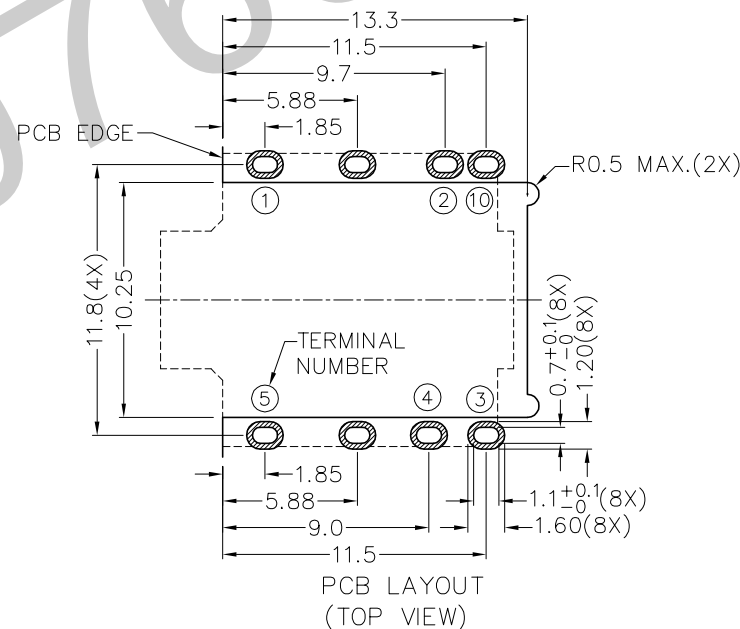

TECHNIK INDUSTRIAL CO.LTD.

DESIGN	H.L.TAN	DATE	12-5-2011	SCALE	3:1
DRAWING	H.L.TAN	DATE	12-5-2011	MATERIAL	*
CHECK		DATE		DWG. NO.	TZ\SH525DS-PA6T/A
APPROVAL		DATE		SHEET	

PART NAME	3.5mm SMD STEREO JACK	TOLERANCE UNLESS	0.0±0.2	UNIT:	mm
PART NO.	TSH-525DS	OTHERWISE SPECIFIED:	0.00±0.1 0.000±0.05		

F

E

D

C

B

A