

F

E

D

C

B

A

RoHS
Compliant

ZONE	SYMBOL	REVISION	APPROVAL	DATE

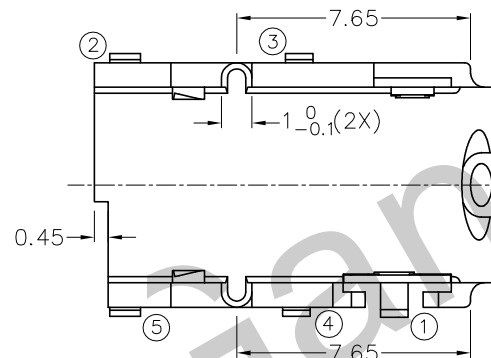
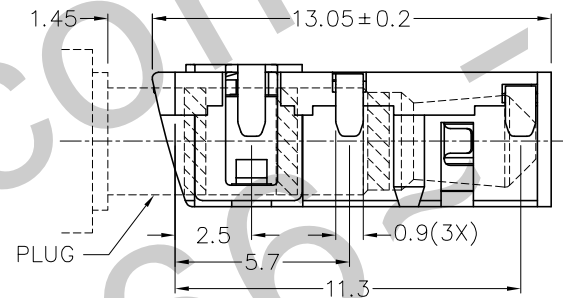
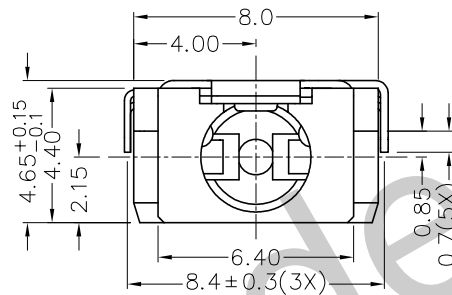
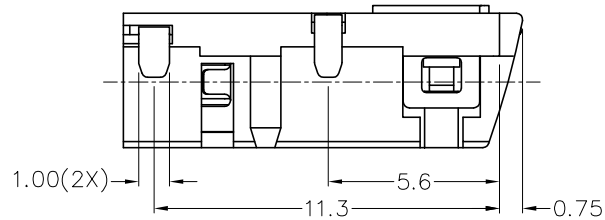
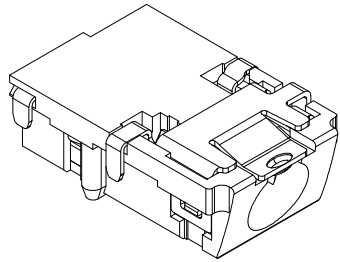

* MATERIAL

TERMINAL 1 : COPPER ALLOY
 TERMINAL 2 : COPPER ALLOY
 TERMINAL 3 : COPPER ALLOY
 TERMINAL 4 : COPPER ALLOY
 TERMINAL 5 : COPPER ALLOY
 HOUSING : PA6T

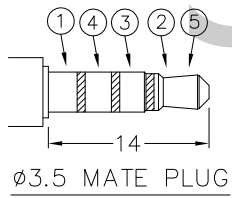
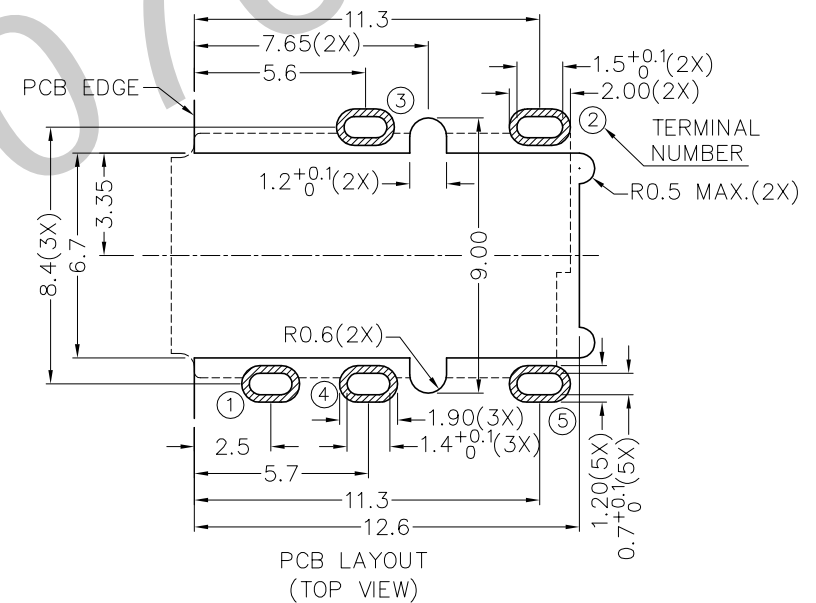
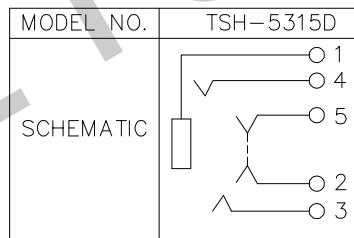

TECHNIK INDUSTRIAL CO.LTD.

PART NAME	3.5mm SMD STEREO JACK	TOLERANCE UNLESS 0.0±0.2 0.00±0.1 OTHERWISE SPECIFIED: 0.000±0.05	UNIT: mm		DESIGN	H.L.TAN	DATE	24-8-2010	SCALE	4:1
					DRAWING	G.P.YI	DATE	22-10-2010	MATERIAL	*
PART NO.	TSH-531D				CHECK		DATE		DWG. NO.	TZ\SH531D-PA6T/A
					APPROVAL		DATE		SHEET	

F

E

D

C

B

A