

F

E

D

C

B

A

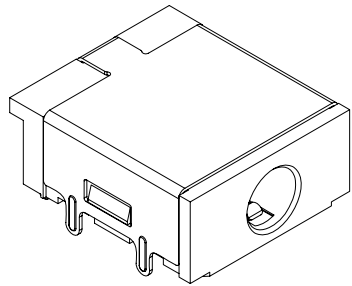

RoHS  
Compliant

ZONE	SYMBOL	REVISION	APPROVAL	DATE

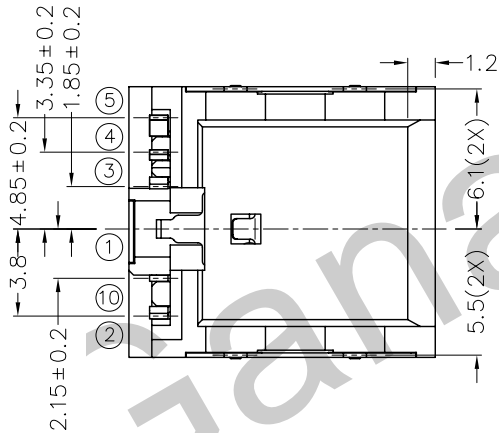
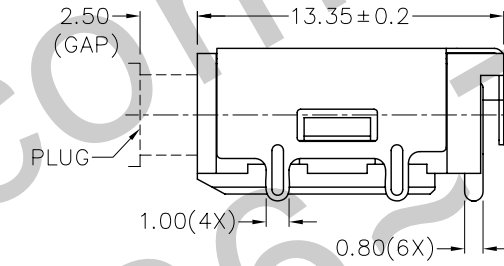
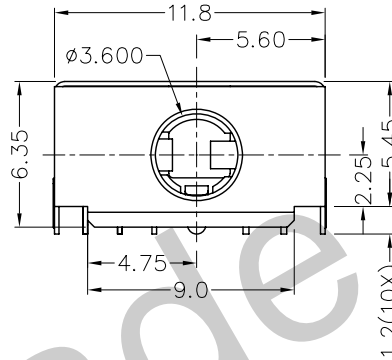
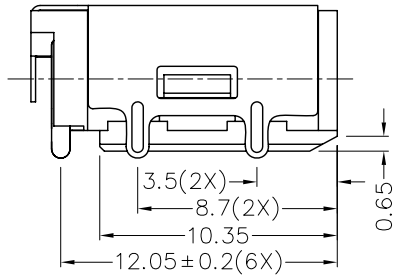

\* MATERIAL

- TERMINAL 1 : COPPER ALLOY
- TERMINAL 2 : COPPER ALLOY
- TERMINAL 3 : COPPER ALLOY
- TERMINAL 4 : COPPER ALLOY
- TERMINAL 5 : COPPER ALLOY
- TERMINAL 10 : BRASS
- SHIELD : BRASS
- HOUSING : PA6T

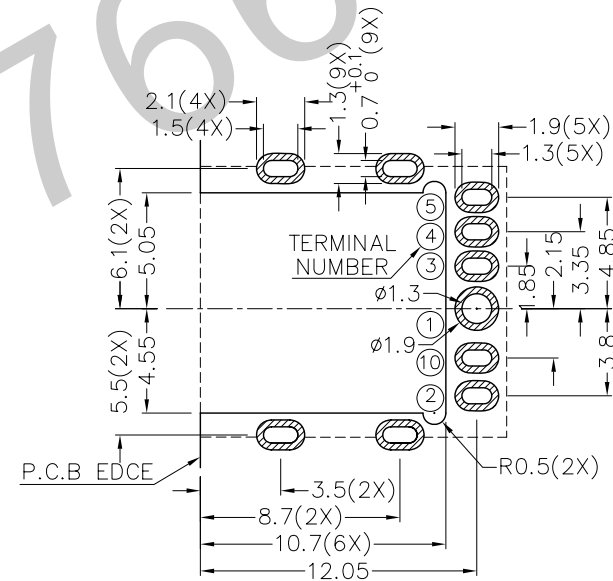
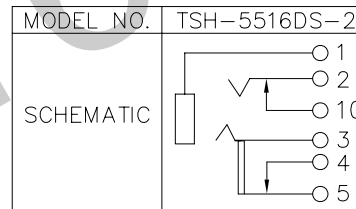

RECOMMENDED PCB LAYOUT  
TOLERANCE: ±0.05  
(TOP VIEW)

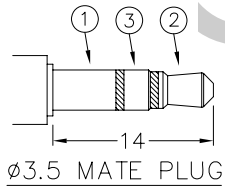

TECHNIK INDUSTRIAL CO.LTD.

DESIGN	CH.XIONG	DATE	20-7-2012	3:SCALE	3:1
DRAWING	CH.XIONG	DATE	3-10-2012	MATERIAL	*
CHECK		DATE		DWG. NO.	TZ\SH551DS-2-PA6T/A
APPROVAL		DATE		SHEET	

PART NAME	3.5mm SMD STEREO JACK	TOLERANCE UNLESS	0.0±0.2	UNIT:	mm
PART NO.	TSH-551DS-2	OTHERWISE SPECIFIED:	0.00±0.1 0.000±0.05		

F

E

D

C

B

A