

F

E

D

C

B

A

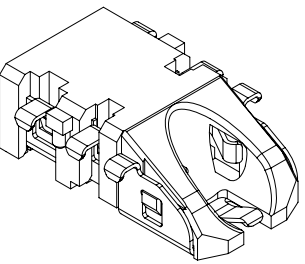

RoHS
Compliant

ZONE	SYMBOL	REVISION	APPROVAL	DATE

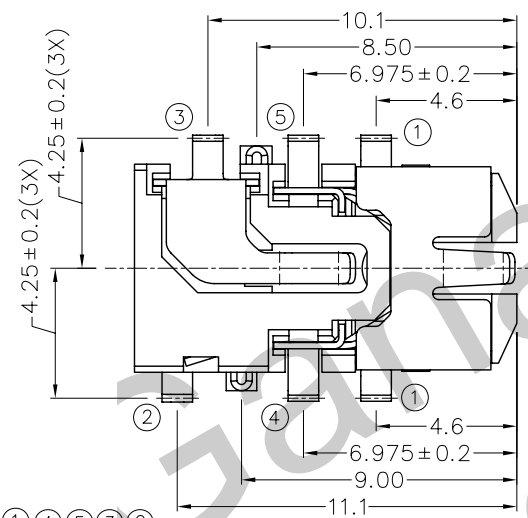
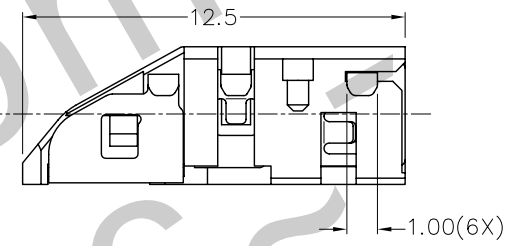
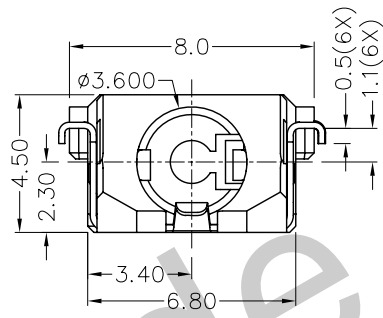
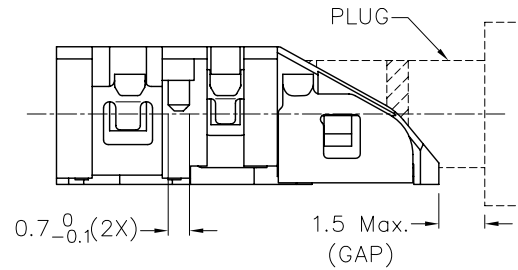

* MATERIAL

- TERMINAL 1 : COPPER ALLOY
- TERMINAL 2 : COPPER ALLOY
- TERMINAL 3 : COPPER ALLOY
- TERMINAL 4 : COPPER ALLOY
- TERMINAL 5 : COPPER ALLOY
- HOUSING : PA6T

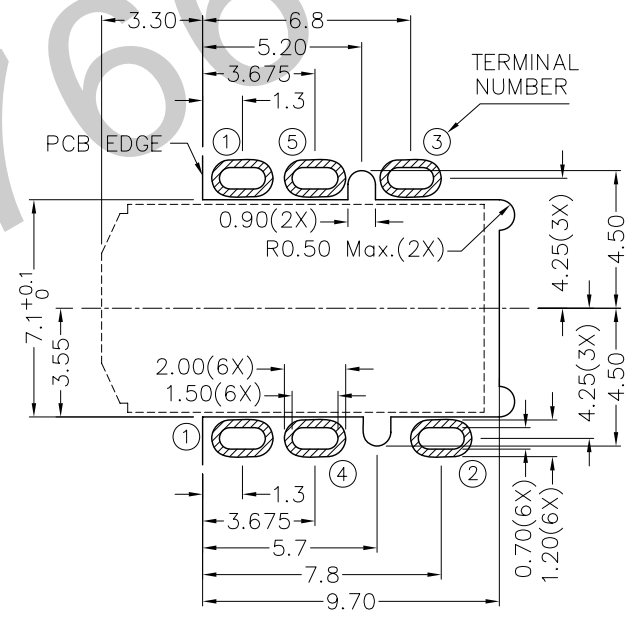

RECOMMENDED
SOLDER PAD LAYOUT
(TOP VIEW)

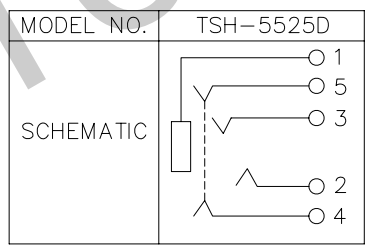
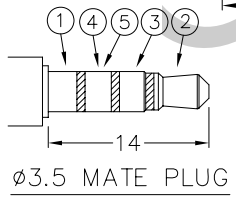

TECHNIK INDUSTRIAL CO. LTD.

PART NAME	3.5mm SMD STEREO JACK	TOLERANCE UNLESS	0.0±0.2	UNIT:	mm
PART NO.	TSH-552D	OTHERWISE SPECIFIED:	0.00±0.1 0.000±0.05		

DESIGN	H.L.TAN	DATE	24-7-2012	SCALE	4:1
DRAWING	H.L.TAN	DATE	7-8-2012	MATERIAL	*
CHECK		DATE		DWG. NO.	TZ\SH552D-PA6T/A
APPROVAL		DATE		SHEET	

F

E

D

C

B

A