

ZONE	SYMBOL	REVISION	APPROVAL	DATE

RoHS
Compliant

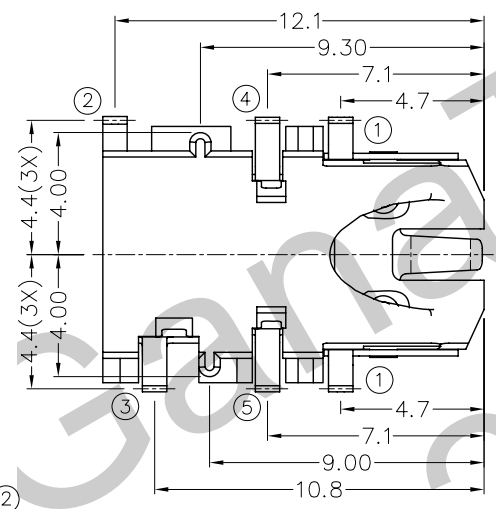
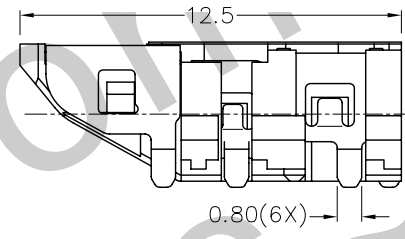
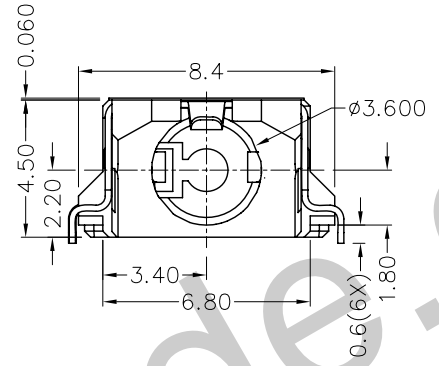
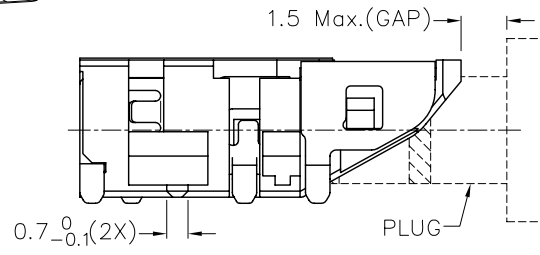
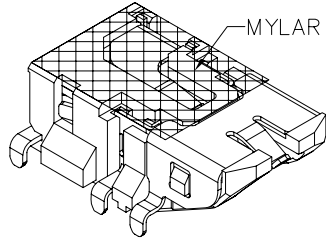

* MATERIAL

- TERMINAL 1 : COPPER ALLOY
- TERMINAL 2 : COPPER ALLOY
- TERMINAL 3 : COPPER ALLOY
- TERMINAL 4 : COPPER ALLOY
- TERMINAL 5 : COPPER ALLOY
- MYLAR : POLYIMIDE
- HOUSING : PA10T

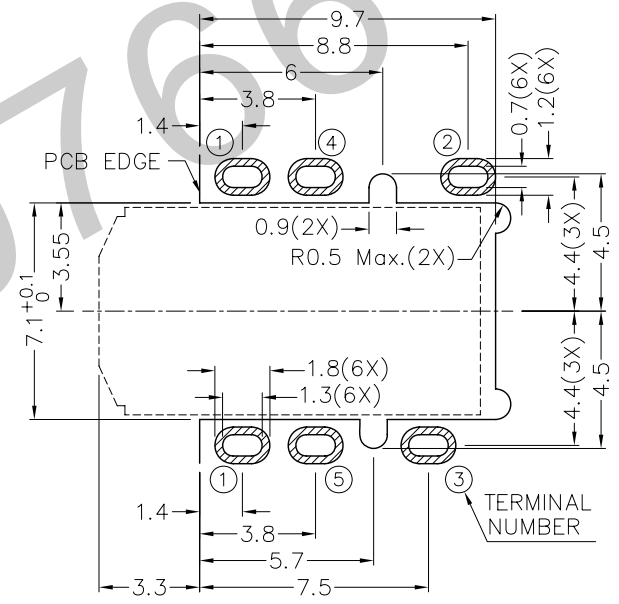
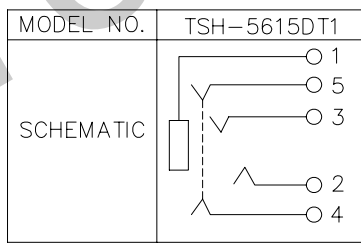

RECOMMENDED PCB LAYOUT
TOLERANCE: ±0.05
(TOP VIEW)

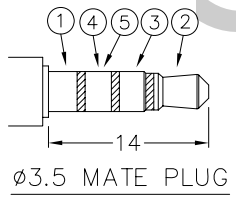

TECHNIK INDUSTRIAL CO.LTD.

DESIGN	T.Y.LI	DATE	31-10-2012	SCALE	4:1
DRAWING	H.L.TAN	DATE	21-11-2012	MATERIAL	*
CHECK		DATE		DWG. NO.	TZ\SH561DT1-PA10T/A
APPROVAL		DATE		SHEET	

PART NAME	3.5mm SMD STEREO JACK	TOLERANCE UNLESS	0.0±0.2	UNIT:	mm
PART NO.	TSH-561DT1	OTHERWISE SPECIFIED:	0.00±0.1 0.000±0.05		