

F

E

D

C

B

A

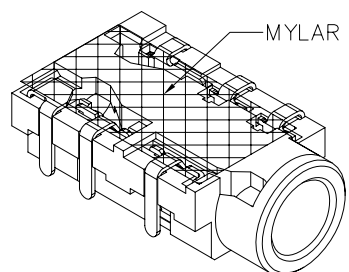

RoHS  
Compliant

ZONE	SYMBOL	REVISION	APPROVAL	DATE

1

1

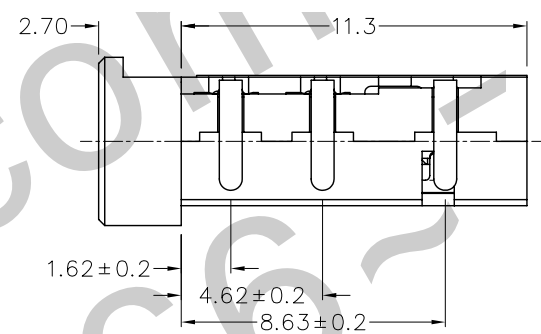
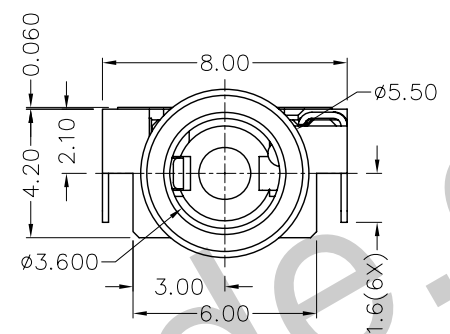
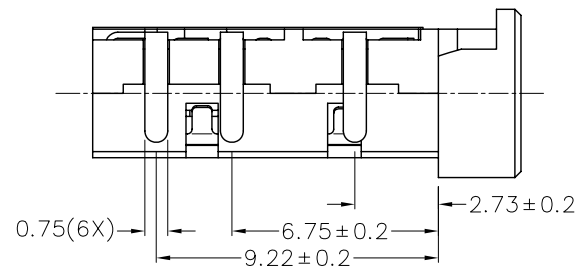

2

2

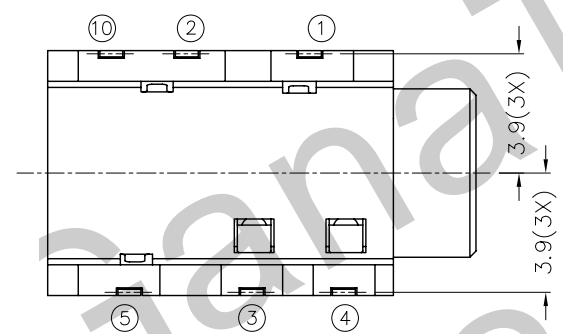

- \* MATERIAL
- TERMINAL 1 : COPPER ALLOY
  - TERMINAL 2 : COPPER ALLOY
  - TERMINAL 3 : COPPER ALLOY
  - TERMINAL 4 : COPPER ALLOY
  - TERMINAL 5 : COPPER ALLOY
  - TERMINAL 10 : COPPER ALLOY
  - MYLAR : POLYIMIDE
  - HOUSING : PA10T

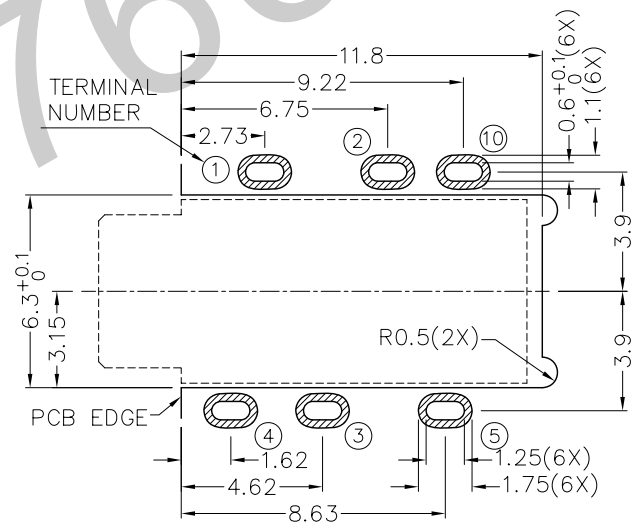

3

3

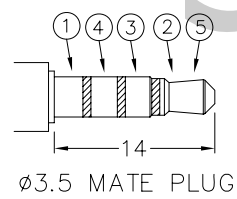
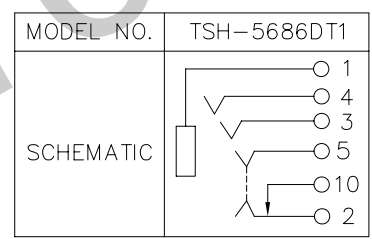

4

4



TECHNIK INDUSTRIAL CO. LTD.

DESIGN	CH.XIONG	DATE	3-12-2012	SCALE	4:1
DRAWING	CH.XIONG	DATE	23-1-2013	MATERIAL	*
CHECK		DATE		DWG. NO.	TZ\SH568DT1-PA10T/A
APPROVAL		DATE		SHEET	

PART NAME	3.5mm SMD STEREO JACK	TOLERANCE UNLESS	0.0±0.2	UNIT:	mm
PART NO.	TSH-568DT1	OTHERWISE SPECIFIED:	0.00±0.1 0.000±0.05		

F

E

D

C

B

A